

OPERATION MANUAL

DAKOTA ULTRASONICS

MVX v2.0

Visual A / B Scan Thickness Gauge

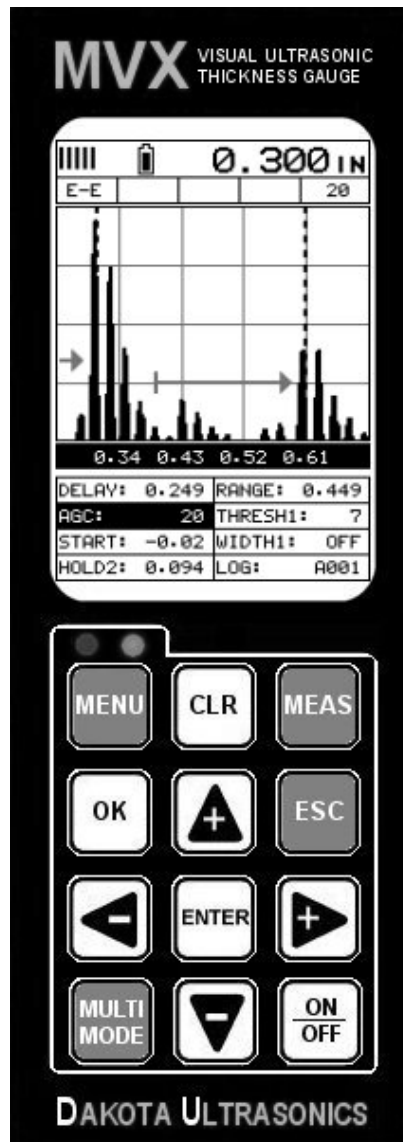

CONTENTS

CHAPTER ONE INTRODUCTION.....	1
1.1 DISCLAIMER.....	1
CHAPTER TWO QUICK STARTUP GUIDE.....	2
2.1 MVX OVERVIEW	2
2.2 SELECTING THE TRANSDUCER TYPE	5
2.3 PROBE ZERO & CALIBRATION	6
2.4 MEASURE	10
CHAPTER THREE KEYBOARD, MENU, & CONNECTOR REFERENCE.....	15
3.1 MENU KEY (OPERATION & SUB MENUS).....	15
3.2 PROBE – MENU.....	17
3.3 CAL – MENU.....	17
3.4 DISP (DISPLAY) – MENU.....	17
3.5 TUNE – MENU.....	18
3.6 GT1 – MENU.....	19
3.7 GT2 – MENU.....	19
3.8 SETUP – MENU.....	20
3.9 DATA – MENU.....	20
3.10 UTIL (UTILITIES) – MENU.....	21
3.11 XFER (TRANSFER) – MENU.....	21
3.12 CLR (CLEAR) KEY.....	22
3.13 MEAS (MEASUREMENT MODE) KEY.....	22
3.14 OK KEY.....	22
3.15 ESC KEY.....	22
3.16 ARROW KEYS.....	22
3.17 ENTER KEY.....	23
3.18 MULTI MODE KEY.....	23
3.19 ON/OFF KEY.....	23
3.20 TOP & BOTTOM END CAPS	24
CHAPTER FOUR PRINCIPALS OF ULTRASONIC MEASUREMENT	25
4.1 TIME VERSUS THICKNESS RELATIONSHIP	25
4.2 SUITABILITY OF MATERIALS	25
4.3 RANGE OF MEASUREMENT AND ACCURACY.....	25
4.4 COUPLANT	25
4.5 TEMPERATURE.....	26

4.6 MEASUREMENT MODES.....	26
CHAPTER FIVE SELECTING THE MEASUREMENT MODE.....	28
5.1 THE SETUP LIBRARY	28
5.2 WHICH MODE & TRANSDUCER DO I USE FOR MY APPLICATION?	28
5.3 FACTORY SETUP CHART	29
CHAPTER SIX MAKING MEASUREMENTS.....	30
6.1 SELECTING THE TRANSDUCER TYPE.....	30
6.2 PROBE ZERO	32
6.3 MATERIAL CALIBRATION	34
CHAPTER SEVEN USING THE DISPLAY OPTIONS	42
7.1 DISPLAY VIEWS.....	43
7.2 CHANGING DISPLAY OPTIONS.....	50
7.3 ADJUSTING THE DISPLAY	50
7.4 GAIN	56
7.5 THRESHOLD.....	60
7.6 UNDERSTANDING THE FEATURES OF THE GATES	63
7.7 ADJUSTING THE GATES	65
CHAPTER EIGHT THRU PAINT MEASUREMENT TECHNIQUE.....	69
8.1 INTRODUCTION TO THRU PAINT MEASUREMENT	69
8.2 USING THRU PAINT MODE	69
CHAPTER NINE ADDITIONAL FEATURES OF THE MVX.....	72
9.1 GRAPHICS OPTIONS (LOOK & FEEL)	72
9.2 POLARITY	73
9.3 PULSE	75
9.4 AUTO FIND	76
9.5 HIGH SPEED SCAN.....	77
9.6 ALARM MODE	78
9.7 DIFFERENTIAL MODE.....	80
9.8 KEY CLICK.....	82
9.9 SET DATE & TIME	83
9.10 SHOW DATE & TIME	84
9.11 FREEZE & CAPTURE.....	85
9.12 CAPTURE VIEWER.....	86
CHAPTER TEN DATA STORAGE – SETUP, EDIT, & VIEW FILES.....	89
10.1 INTRODUCTION TO THE GRID FILE FORMAT	89

10.2 CREATING A NEW GRID.....	90
10.3 STORING A READING.....	98
10.4 VIEWING STORED READINGS.....	99
10.5 DELETING GRIDS (FILES).....	101
10.6 EDITING A GRID (FILE).....	104
10.7 CHANGING THE ACTIVE FILE - OPEN.....	106
10.8 CLOSING AN ACTIVE FILE - CLOSE.....	108

CHAPTER ELEVEN SETUPS – CREATE, STORE, EDIT, & RECALL.....111

11.1 INTRODUCTION TO SETUPS.....	111
11.2 OPENING A SETUP.....	111
11.3 SAVING A SETUP.....	113
11.4 DELETING A SAVED SETUP.....	117
11.5 USING THE DEFAULT SETUP.....	119
11.6 SELECTING A LANGUAGE.....	120

CHAPTER TWELVE USING THE UTILITY SOFTWARE121

12.1 COMPUTER SYSTEM REQUIREMENTS.....	121
12.2 INSTALLING DAKVIEW.....	121
12.3 COMMUNICATING WITH THE <i>MVX</i>	121
12.4 LINE POWER.....	121
12.5 UPGRADING THE <i>MVX</i>	121

APPENDIX A - VELOCITY TABLE123

APPENDIX B - SETUP LIBRARY125

CHAPTER ONE INTRODUCTION

The Dakota Ultrasonics model **MVX** is a visual A / B scan ultrasonic thickness gauge. Based on the same operating principles as SONAR, the **MVX** is capable of measuring the thickness of various materials with accuracy as high as ± 0.001 inches, or ± 0.01 millimeters. The principle advantage of ultrasonic measurement over traditional methods is that ultrasonic measurements can be performed with access to only one side of the material being measured.

Dakota Ultrasonics maintains a customer support resource in order to assist users with questions or difficulties not covered in this manual. Customer support may be reached at any of the following:

Dakota Ultrasonics Corporation
1500 Green Hills Road, #107
Scotts Valley, CA 95066 USA
Telephone: (831) 431-9722
Facsimile: (831) 431-9723
www.dakotaultrasonics.com

1.1 Disclaimer

Inherent in ultrasonic thickness measurement is the possibility that the instrument will use the second rather than the first echo from the back surface of the material being measured. This may result in a thickness reading that is TWICE what it should be. Responsibility for proper use of the instrument and recognition of this phenomenon rest solely with the user of the instrument. Other errors may occur from measuring coated materials where the coating is insufficiently bonded to the material surface. Irregular and inaccurate readings may result. Again, the user is responsible for proper use and interpretation of the measurements acquired.

CHAPTER TWO QUICK STARTUP GUIDE

Turn the **MVX** on and off using the switch located on the bottom right corner of the keypad. When **MVX** is initially turned on, a flash logo and blinking lights will be displayed prior to entering into the main measurement screen.

Note: This section is primarily written as a basic startup guide only.

2.1 MVX Overview

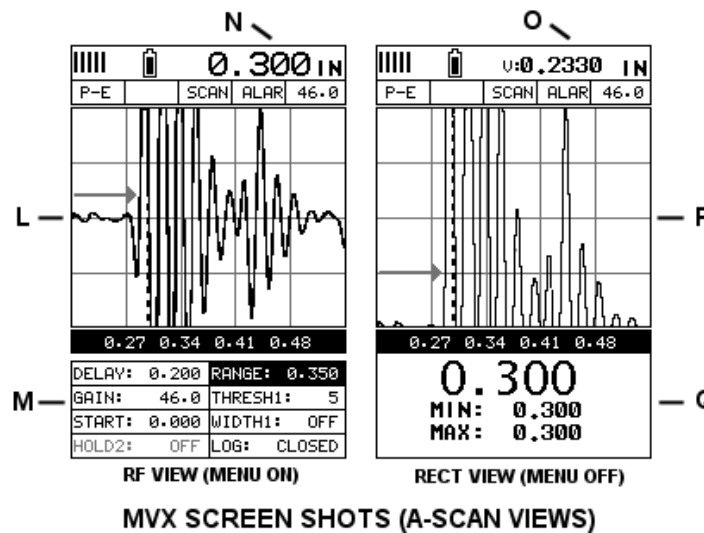
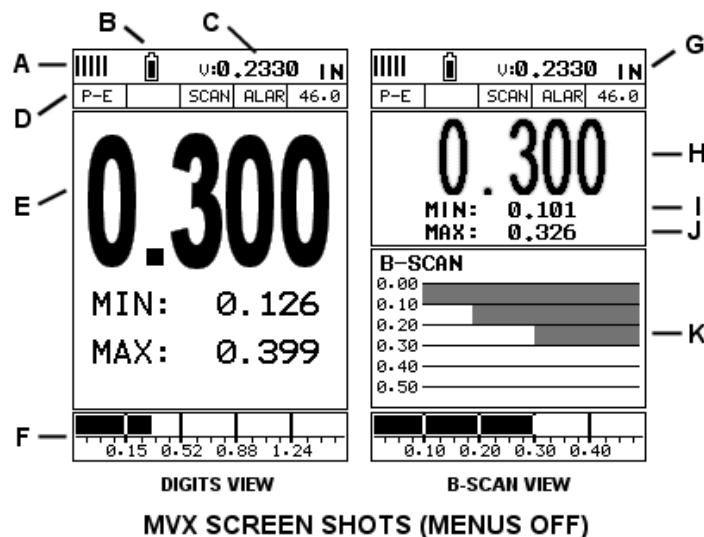

In order to understand how to operate the **MVX**, it's best to start off with an understanding of what it is we're looking at exactly. The **MVX** has a lot of great features and tools that will prove to be a huge benefit for the variety of applications you're constantly facing on a continual basis. Let's have a brief look at the screens you'll be looking at most often:

- A. **Repeatability/Stability Indicator** – This indicator should be commonly used in conjunction with the digital thickness values displayed. When all the vertical bars are fully illuminated and the last digit on the digital thickness value is stable, the **MVX** is reliably measuring the same value 250 times per second (250 Hz).
- B. **Battery Icon** – Indicates the amount of battery life the **MVX** has remaining.
- C. **Velocity** – The material velocity value the **MVX** is currently using or calibrated for. Displayed in both English or Metric units, depending on what units the gauge is set for.
- D. **Feature Status Bar** – Indicates the features currently enabled and in use in the following order:
 - Measurement Mode
 - Differential Mode
 - High Speed Scan Mode
 - Alarm Mode
 - Gain Setting
- E. **Digital Material Thickness Value** – Extra large font size for viewing ease.
- F. **Scan Bar** – Another view of material thickness in a deflection style horizontal bar. This is a visual tool that would enable the user the ability to see thickness changes during high speed scans from flaws and pits.
- G. **Units** – The current measurement units being used (English, Metric).
- H. **Digital Material Thickness Value** – Smaller font size when the B-Scan display view is enabled.
- I. **Minimum Material Thickness** – Part of the scan feature. Displays the minimum thickness value found during a scan.
- J. **Maximum Material Thickness** – Part of the scan feature. Displays the maximum thickness value found during a scan.
- K. **B-Scan Display** – Cross section view of the material. Provides the user with graphical view of the opposite/blind surface (i.e. inside pipe wall surface), to give the user some idea of the condition, or integrity of the material being tested.
- L. **RF A-Scan Display** – The actual sound wave reflection that is returned from the detection of the opposite surface of the material being measured. In this view, the entire sine wave is displayed, showing both the positive and negative half cycles from the detection/reflection. This view is commonly used to

initially “see the big picture” and make fine adjustments to the scope settings, prior to selecting another view option.

- M. **Hot Menu items** – We call this menu section our “hot menu”, as these items are the most commonly adjusted features, requiring quick access from the user. They can be displayed and scrolled by pressing the MEAS key at anytime. The ESC key is used in conjunction with MEAS key to reverse the direction scrolled.
- N. **Reference Note** – When the “hot menu” items are displayed/activated, the base material thickness value shown at reference point “N”. However, when the “hot menu” items have been deactivated, the current base material velocity value is displayed, as shown in reference point “O”. When the “hot menus” are deactivated, the entire “hot menu” section becomes a multiple measurement display area, allowing the user to simultaneously view: base material and base material minimum/maximum thickness values dynamically, as shown in reference point “Q”.
- O. **Reference Note** – Please refer to “N” for a detailed explanation.
- P. **RECT A-Scan Display** – The actual sound wave reflection that is returned from the detection of the opposite surface of the material being measured. In this view, only half of the sine wave is being displayed (positive or negative). This view is commonly referred, and used as a “flaw detection” mode, once the user made all the necessary adjustments using the RF mode (refer to L).
- Q. **Reference Note** – Please refer to “N” for a detailed explanation.

2.2 Selecting the Transducer Type

The **MVX** is equipped with a transducer list of all of the dual element transducer options that can be connected to the gauge. These are dual element transducers with different diameters and frequencies, depending on the material and application requirements. Transducers with an HD (high damped) designation are commonly used in conjunction with E-E (echo-echo) through paint modes, while CPZT (composite) are used for additional output with materials that are difficult to pass sound through. Finally, the majority of the transducers listed in the table are standard diameter/frequency transducers used in P-E (pulse-echo) mode. By selecting the transducer type from a predefined list, the **MVX** can recall specific properties about the transducer.

Note: *Once the transducer has been selected, the **MVX** will store and recall this transducer type every time the **MVX** is powered on/off. The type will only change if the user physically selects another transducer type from the list, or selects a previously saved setup. You'll notice that the probe type previously selected will be highlighted every time the probe type screen is displayed.*

Use the following steps to select your transducer type:

Selecting the Transducer Type

SETUP PROBE

ZERO PROBE

TYPE 1

PRB CAL DISP TUNE

- 1) Press the **MENU** key once to activate the menu items tab. Press the **MENU** key multiple times to tab right and the **ESC** key multiple times to tab left until the **PRB** menu is highlighted and displaying the submenu items.
- 2) Use the **UP** and **DOWN** arrow keys to scroll through the sub menu items until **TYPE** is highlighted.

PROBE TYPE	
1.	3/16IN - 5.0MHZ
2.	3/16IN - 7.5MHZ
3.	3/16IN - 10.0MHZ
4.	1/4IN - 2.25MHZ
5.	1/4IN - 5.0MHZ
6.	1/4IN - 5.0MHZ HD
7.	1/4IN - 7.5MHZ
8.	1/4IN - 7.5MHZ HD
9.	1/4IN - 10.0MHZ
10.	1/2IN - 1.0MHZ
11.	1/2IN - 1.0MHZ CPZT
12.	1/2IN - 2.25MHZ
13.	1/2IN - 2.25MHZ CPZT
14.	1/2IN - 3.5MHZ HD
15.	1/2IN - 5.0MHZ
16.	1/2IN - 7.5MHZ

- 3) Press the **ENTER** key to display the table/list of transducers.
- 4) Use the **UP** and **DOWN** arrow keys to highlight the transducer type currently connected to the gauge.
- 5) Press the **ENTER** key to load the transducer type and display the confirmation screen.

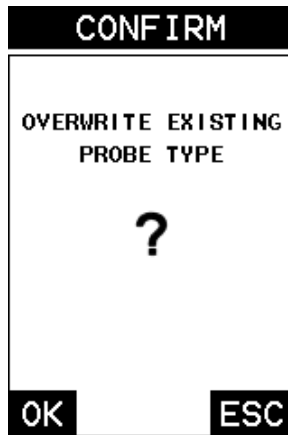

- 6) Press the **OK** key to overwrite the existing probe type, or **ESC** to cancel.

2.3 Probe Zero & Calibration

The next steps are to perform a probe zero and calibrate the **MVX** to the material and transducer selected. If the sound velocity is unknown, the **MVX** can be calibrated to a known thickness sample. The procedures are outlined as follows:

Performing a Probe Zero

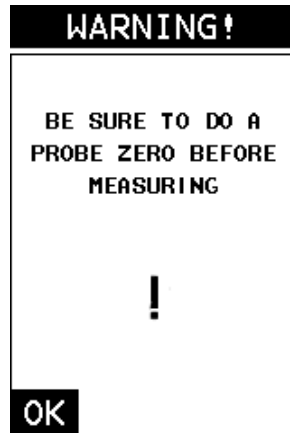

Note: *The probe zero disk (battery cap) is located on the top end cap of the gauge. The warning screen will be displayed following the selection and overwrite of a new transducer.*

- 1) Press the **OK** key to enter the main measurement screen and begin the manual zero process.
- 2) Apply a drop of couplant on the transducer and place the transducer in steady contact with the probe zero disk.
- 3) Press the **MENU** key once to activate the menu items tab. Press the **MENU** key multiple times to tab right and the **ESC** key multiple times to tab left until the **PRB** menu is highlighted and displaying the submenu items.
- 4) Press the **UP** and **DOWN** arrow keys to scroll through the sub menu items until **ZERO PROBE** is highlighted.

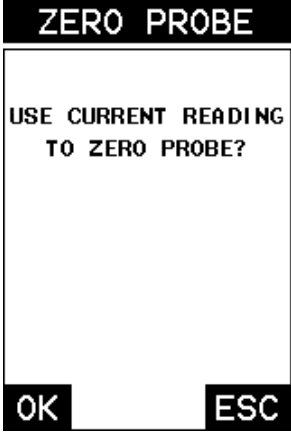

5) Press the **ENTER** key to display the confirmation screen.

6) Press the **OK** key to complete the probe zero process, or **ESC** key to cancel zeroing.

7) Remove the transducer from the probe zero disk, and proceed to the calibration section.

Note: *The value that is displayed will change depending on the current velocity setting in the **MVX**. Disregard the number that is displayed. **It is not important.** What is important is accurately performing the steps outlined above to insure reliability of the probe zero calculation.*

One Point Material Calibration

For the purposes of this quick start section, the most common single point calibration option will be covered in this section.

Note: *It would be very handy to carry a set of mechanical calipers to use in conjunction with the **MVX** for calibration in the field.*

Known Thickness

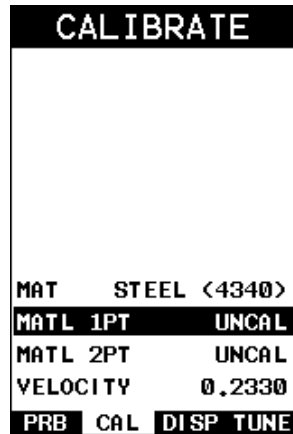

Note: Be sure a probe zero has been performed prior to calibration.

- 1) Physically measure an exact sample of the material, or a specific location directly on the material using a set of calipers or a digital micrometer.
- 2) Apply a drop of couplant on the transducer and place the transducer in steady contact with the sample or actual test material measured. Be sure the measurement is stable and the repeatability indicator, in the top left corner of the display, is fully lit and stable. Press the **MENU** key once to activate the menu items tab. Press the **MENU** key multiple times to tab right and the **ESC** key multiple times to tab left until the **CAL** menu is highlighted and displaying the submenu items.
- 3) Use the **UP** and **DOWN** arrow keys to scroll through the sub menu items until **MATL 1PT** is highlighted.



- 4) Press the **ENTER** key to display the **Digits Edit Box**.
- 5) Press the **UP** and **DOWN** arrow keys to scroll the highlighted value.
- 6) Press the **LEFT** and **RIGHT** arrow keys to scroll the digit locations.
- 7) Repeat steps **5 & 6** until the known thickness value is correctly displayed.
- 8) Press the **OK** key to calculate the velocity and return to the menu screen, or **ESC** to cancel the one point calibration.
- 9) Finally, press the **MEAS** key to return to the measurement screen and begin taking readings.

Note: ***CHECK YOUR CALIBRATION!** Place the transducer back on the calibration point. The thickness reading should now match the known thickness. If the thickness is not correct, repeat the steps above.*

2.4 Measure

The **MVX** is now ready to measure. There are four different measurement view options, each with a specific purpose – Digits, RF, RECT, & B-Scan. The steps below outline how to toggle between the different view mode options:

Selecting the Measurement View Option

SET DISPLAY	
VIEW	RF
DELAY	0.000
RANGE	1.000
B-SCAN SPEED	6
UNITS	IN
BACKLIGHT	OFF
CONTRAST	10
RECT WAVE	OUTLINE
DETECT MARK	DOTS
PRB	CAL
DISP	TUNE

- 1) Press the **MENU** key once to activate the menu items tab. Press the **MENU** key multiple times to tab right and the **ESC** key multiple times to tab left until the **DISP** menu is highlighted and displaying the submenu items.
- 2) Use the **UP** and **DOWN** arrow keys to scroll through the sub menu items until **VIEW** is highlighted.
- 3) Use the **LEFT** and **RIGHT** arrow keys to scroll the view options.
- 4) Once the view is displayed, press the **MEAS** key to return to measurement mode.

DIGITS: Displays the digital thickness value using a large font size. This view is useful when the **MVX** is being used as a basic thickness gauge.

RF: Displays the actual waveform signal, much like an oscilloscope, from the reflection of the opposite surface, pit, flaw, crack or void. This view shows both the positive and negative peaks, and is often used to fine tune the scope settings, prior to inspection.

RECT: Displays a half waveform signal, either positive or negative, from the reflection of the opposite surface, pit, flaw, crack or void. The user can select the polarity or “phase” displayed. This is typically determined by first using RF view to select the most optimal polarity “phase”, to fine tune the scopes settings. The RECT view is commonly used as the primary “flaw detection” view.

BSCAN: The Time Based B-Scan provides the user with a cross sectional view of the material being tested. This mode is useful when there is concern regarding the

profile of the blind surface. This can also be a useful view when scanning for pits and flaws.

Once the view has been selected according to the application requirements, the **Delay** and **Range** of the screen will potentially need to be adjusted, if the view has been set to **RF** or **RECT**. Alternatively, if **BSCAN** was selected, the **B-Start** and **B-Depth** settings will need to be adjusted. These settings serve the same purpose, with only differences in terminology. The **Delay** is the same as **B-Start**, and **Range** the same as **B-Depth**. These will be grouped together for the duration of this manual as follows: **Delay (B-Start)** and **Range (B-Depth)**.

Use the following steps to adjust these settings directly from the measurement screen as follows:

Note: *The **Delay (B-Start)** and **Range (B-Depth)** are also used to adjust the parameters of **Scan Bar**.*

Adjusting Delay (B-Start) & Range (B-Depth)

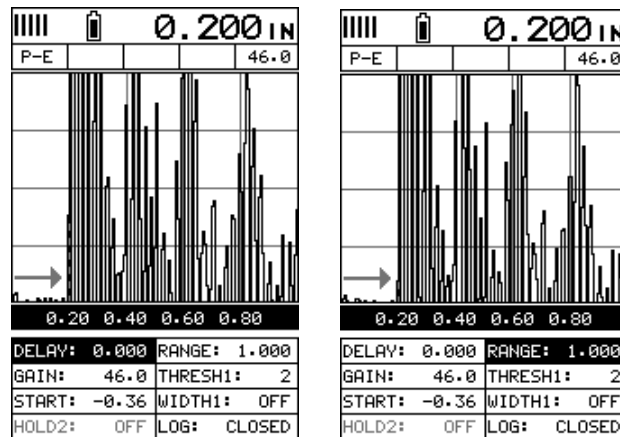

- 1) Press the **MEAS** key once to activate the measure menu items. Press the **MEAS** key multiple times to move right and the **ESC** key multiple times to move left, until the either the **DELAY (START)** or **RANGE (DEPTH)** cell is highlighted.
- 2) Use the **UP**, **DOWN**, **LEFT**, or **RIGHT** arrow keys to scroll the **DELAY (START)** and **RANGE (DEPTH)** values.
- 3) Repeat steps 1 & 2 until the range is correctly being displayed.

Alternatively, the **DELAY (START)** and **RANGE (DEPTH)** values can be changed using the **Digit Edit Box** as follows:

- 4) Press the **MEAS** key once to activate measure menu items. Press the **MEAS** key multiple times to move right and the **ESC** key multiple times to move left, until the either the **DELAY (START)** or **RANGE (DEPTH)** cell is highlighted.

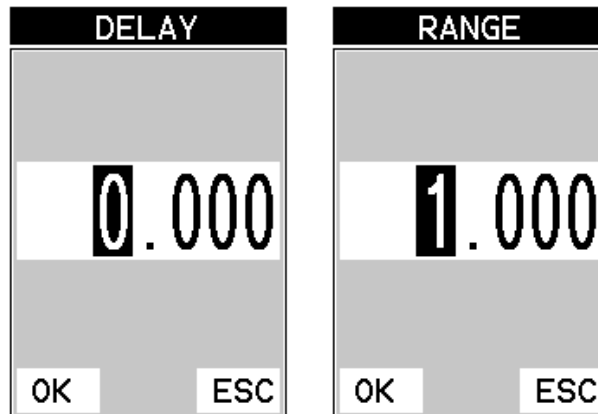

- 1) Press the **ENTER** key to display the digits edit box.
- 2) Press the **UP** and **DOWN** arrow keys to scroll the highlighted value.
- 3) Press the **LEFT** and **RIGHT** arrow keys to scroll the digit locations.
- 4) Repeat steps 3 & 4 until the **DELAY (START)** or **RANGE (DEPTH)** value is correctly displayed.
- 5) Press the **OK** key to set the **DELAY (START)** and **WIDTH (DEPTH)** value and return to the measure screen, or **ESC** to cancel entering the **DELAY (START)** or **WIDTH (DEPTH)** value.
- 6) Finally, press the **MEAS** key to return to the measurement screen and begin taking readings.

Note: *The **DELAY (START)** & **WIDTH (DEPTH)** can also be adjusted from the tabbed menu item **DISP**. However, using the hot menu keys is the easiest method.*

CHAPTER THREE KEYBOARD, MENU, & CONNECTOR REFERENCE



3.1 Menu Key (Operation & Sub Menus)



The **Menu** key activates the primary menu structure containing 8 menu tab groups. These tab groups then contain sub menu items, or functions. The sub menu items have been organized in tab groups according to how closely they are related to the individual tab group names. Let's first get familiar with how to move around in these tabs before continuing on to the sub menu functions. This procedure is outlined below:

Activating and Getting Around in the Menu Items

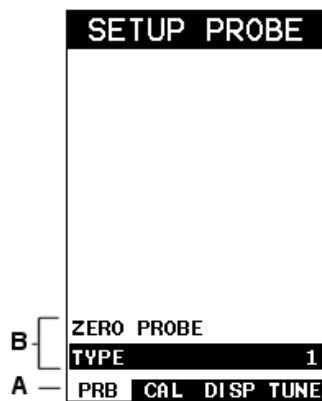

- 1) Press the **MENU** key once to activate the menu items tab. Press the **MENU** key multiple times to tab right, and the **ESC** key multiple times to tab left until the desired tab group is highlighted and displaying the submenu items. The tab groups are illustrated above **(A)**.

Now that you're familiar with activating and moving amongst the tab groups, let's have a look at how to move around in the sub menu items as follows:

Getting Around in the Sub Menu Items

- 1) Use the **UP** and **DOWN** arrow keys to scroll through the sub menu items until the desired function is highlighted. The sub menu items are illustrated in the diagram above **(B)**.
- 2) Depending on which function is highlighted, use the **LEFT**, **RIGHT**, and **Enter** keys to scroll the options or activate the **Digit Edit** and **List Box** options.

The sections to follow will provide the user with an explanation of the sub menu functions:

3.2 Probe – Menu

ZERO PROBE	
TYPE	5
PRB	CAL DISP TUNE

ZERO PROBE: The **MVX** is zeroed in much the same way that a mechanical micrometer is zeroed. If the **MVX** is not zeroed correctly, all of the measurements made using the **MVX** may be in error by some fixed value. The **MVX** is equipped with an optional automatic or manual zero feature. Refer to the section on page 32, for an explanation of this important procedure.

TYPE: Enables the user to select the type of transducer being used from a chart of transducer types. This provides increased linearity between transducers. Refer to page 5 for a further explanation.

3.3 CAL – Menu

MAT	STEEL <4340>
MATL 1PT	UNCAL
MATL 2PT	UNCAL
VELOCITY	0.2330
PRB	CAL DISP TUNE

MAT: Select the material velocity from a chart of basic material types when a known sample thickness, or material velocity cannot be obtained. Refer to page 39 for further info.

MATL 1PT: Performs a single point calibration. This option allows the user to automatically calculate the velocity by entering a known sample thickness. Refer to page 36 for further info.

MATL 2PT: Performs a two-point calibration. This option allows the user to automatically calculate the velocity by entering a second known sample thickness. Refer to page 38 for further info.

VELOCITY: Function to calibrate the **MVX** by setting the velocity to a known material velocity. Refer to page 34 for further info.

3.4 DISP (display) – Menu

VIEW	+RECT	VIEW	BSCAN
DELAY	0.000	B-START	0.000
RANGE	1.000	B-DEPTH	0.500
B-SCAN SPEED	6	B-SCAN SPEED	6
UNITS	IN	UNITS	IN
BACKLIGHT	OFF	BACKLIGHT	OFF
CONTRAST	10	CONTRAST	10
RECT WAVE	OUTLINE	RECT WAVE	OUTLINE
DETECT MARK	DOTS	DETECT MARK	DOTS
PRB	CAL DISP TUNE	PRB	CAL DISP TUNE

VIEW: Selectable BSCAN (cross section), and DIGITS (large digits) views. Refer to page 43 for further info.

DELAY (B-START): Provides the user the ability to change the start position of the B-SCAN view. Refer to page 51 for further info.

RANGE (B-DEPTH): Provides the user the ability to change the overall depth of the viewable measurement area. It functions a lot like a zoom on a camera. Refer to page 53 for further info.

B-SCAN SPEED: Controls the speed of the time based B-Scan with an arbitrary scale of 0-10, with 10 being the fastest scrolling speed. Default speed set at 6. Refer to page 55 for further info.

UNITS: Toggle between English or Metric units. The readout will change from inches to millimeters (0.001" / 0.01mm).

BACKLIGHT: Selectable OFF, ON, AUTO, or INVERT backlight option.

CONTRAST: Adjustable display contrast for variable light conditions.

RECT WAVE: This option provides the user an outlined or filled view option when the display setting is in RECT (rectified) wave mode only. Refer to page 72 for further info.

DETECT MARK: Selectable graphics option for the point of detection on the waveform: Line, Box, Dots, None. Offers the user a graphics preference on how they prefer to view the detection on the waveform. Refer to page 72 for further info.

MEASURE MODE	P-E
POLARITY	POSITIVE
PULSE	THIN
GAIN	46.0
AGC	21
PRB CAL DISP TUNE	

3.5 TUNE – Menu

MEASURE MODE: Toggles a variety of unique measurement modes for different application requirements: Coating Off (P-E), Coating On (PECT), Temp Comp (PETP), Thru Coat (E-E), Thru Verify (E-EV), Coating Only (CT). Refer to page 26 for further info.

POLARITY: The *MX* operates on a zero crossing detection principle. This feature toggles which stroke of the cycle the crossing detection uses, either positive or negative. Refer to page 73 for further info.

PULSE: The *MX* has an adjustable pulse width for both high penetration and resolution applications. The pulse width refers to the duration of time the pulser is on. The options are **Spike**, **Thin**, and **Wide**. Refer to page 75 for a further explanation.

GAIN: The *MX* has 46dB gain range from (10 to 56 dB). This feature is used to increase/decrease the power or amplitude of the signal and. This might easily be considered as similar to turning the volume up or down on a stereo receiver. Refer to page 56 for further info.

AGC: Automatic gain control used in E-E (echo-echo) mode. This feature automatically increases/decreases the power or amplitude of the signal to an optimal input to output ratio. Alternatively, the dynamic range of the AGC can be manually adjusted. The adjustment range is an arbitrary 1-20 scale, the higher the number the larger the dynamic range. Refer to page 56 for further info.

START	-0.36
WIDTH 1	OFF
THRESHOLD 1	2
GT1	GT2 SET DATA

3.6 GT1 – Menu

GATE1: Gates allow the user to view a specific measurement range, or sections of the waveform, and ignore others. The Gate1 feature adjusts the start of the gate, according to time/distance. Gate 1 can be used in all pulse-echo and echo-echo measurement modes. Refer to page 63 for further info.

GATE1 WIDTH: This feature allows the user to set the overall width of the gate, in terms of distance, from the starting value of Gate1. Refer to page 63 for further info.

THRESHOLD1: Enables the user to set the sensitivity level of Gate1. The amplitude of the signal must reach or exceed the threshold level before a measurement is detected. Refer to page 63 for further info.

WIDTH 2	OFF
HOLD2	0.095
THRESHOLD 2	5
GT1	GT2 SET DATA

3.7 GT2 – Menu

GATE2 WIDTH: This feature allows the user to set the overall width of the gate, in terms of distance, from the starting value of HoldOff2. Refer to page 63 for further info.

HOLDOFF 2: Provides the user with the ability to delay the starting point of Gate2, a specific distance from the first detection point found inside of the boundaries of the Gate 1 settings. If no detection is found, the Gate1 width value is used as a starting value for Gate2. Refer to page 63 for further info.

THRESHOLD2: Enables the user to set the sensitivity level of Gate2. The amplitude of the signal must reach or exceed the threshold level before a measurement is detected. Refer to page 63 for further info.

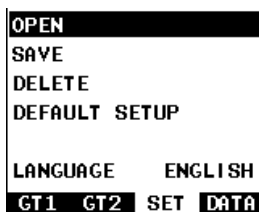

3.8 SETUP – Menu

OPEN: Displays a list of factory and user defined setups currently stored in memory. These setups can be recalled and used at any time. Refer to page 111 for further info.

SAVE: Provides the user with the ability to save a custom setup that has been modified or created by the user. Refer to page 113 for further info.

DELETE: Provides the user with the ability to delete specific setups previously save in memory. Refer to page 117 for further info.

DEFAULT SETUP: Loads a basic default setup. Use only as a last resort when the setups in the *MVX* have been corrupted and a computer is not accessible. Refer to page 119 for further info.

LANGUAGE: Provides the user the ability to select different languages for the *MVX*. Refer to page 120 for further info.



3.9 DATA – Menu

NEW: Allows the user the ability to create a new alpha numeric grid, or sequential log file with auto identifiers. It is equipped with custom parameters, rows, and columns depending on the user's application reporting requirements. Refer to page 90 for further info.

EDIT: Gives the user the ability to change parameters of grid or sequential file previously saved. Note: Pre-defined coordinates cannot be changed once they have been created. Refer to page 104 for further info.

OPEN: This function provides the user with the ability to recall grids or sequential log files that currently exist in memory, from a list of grids. Refer to page 106 for further info.

CLOSE: Provides the user the ability to close a currently opened grid or sequential log file. Refer to page 108 for further info.

DELETE ONE FILE: This function provides the user with the ability to delete one individual grid or sequential log file from a list of multiple grids/files previously saved in memory. Refer to page 101 for further info.

DELETE ALL DATA: This function provides the user with the ability to delete all files currently stored in memory. Refer to page 102 for further info.

AUTO FIND	
SCAN MODE	OFF
ALARM	OFF
ALARM HIGH	0.500
ALARM LOW	0.000
DIFFERENTIAL	OFF
KEY CLICK	QUIET
SET DATE	MMDDYY
SHOW DATE	OFF
UTIL XFER	

3.10 UTIL (utilities) – Menu

AUTO FIND: Automatically locates the detection point if the measurement is out of the viewable display area. Refer to page 76 for further info.

SCAN MODE: This function enables a high speed scan mode that increases the overall sample rate from 65 to 200 measurements per second, depending on the current measurement mode used. Refer to page 77 for further info.

ALARM: Toggles alarm mode on, off, or audible. Refer to page 78 for further info.

ALARM HIGH: Gives the user the ability to set the HI limit parameter. If the measurement exceeds this value, a red light will illuminate and sound the internal beeper. Refer to page 78 for further info.

ALARM LOW: Gives the user the ability to set the LO limit parameter. If the measurement falls below this value, a red light will illuminate and sound the internal beeper. Refer to page 78 for further info.

DIFFERENTIAL: Gives the user the ability to set a nominal value and the **MVX** will display +/- the difference from the nominal value entered. Refer to page 80 for further info.

KEY CLICK: Give the user the ability to set the level of the key press beeper, OFF, QUIET, or LOUD. Refer to page 82 for further info.

SET DATE: Gives the user the ability to set the internal date and time stamp in the **MVX**. Refer to page 83 for further info.

SHOW DATE: Gives the user the ability to display the date and time in the waveform area of the **MVX**. The options are OFF, DATE, TIME, BOTH. Refer to page 84 for further info.

UPGRADE GAUGE	
CAPTURE VIEWER	
ABOUT	DEV 3.02H
UTIL XFER	

3.11 XFER (transfer) – Menu

UPGRADE GAUGE: Enables the user the ability to upgrade the **MVX** to the most current firmware revision. Latest version posted on www.dakotaultrasonics.com.

CAPTURE VIEWER: Enables the user to view all the captured (.tif) files stored in the *MOVX* on the gauge display. Refer to page 86 for further info.

ABOUT: Provides the user with Dakota Ultrasonics contact information and the *MOVX* firmware version. Refer to the Dakota Ultrasonics web site for information on the latest firmware versions available for download.



3.12 CLR (clear) Key

The primary functions of the **CLR** key, is to clear a measurement from a grid file cell location, set an obstruct, or backspace in an **Alpha Edit Box**. If a user has already saved a measurement and B-Scan to a cell location, use this key to clear the measurement at any time.



3.13 MEAS (measurement mode) Key

The **MEAS** key returns the *MOVX* to the primary measurement screen. Press at any time to view the main screen.



3.14 OK Key

The primary function of the **OK** key is confirmation of a change or selection. Additionally, the **OK** key also toggles the **Hot Menu** area to a **large digits** display while in measurement mode. If the *MOVX* is displaying a grid log, the **OK** key toggles an advance to row number option.



3.15 ESC Key

The **ESC** key is used in the **MENU**, **MEAS**, and **EDIT** functions as a back or escape function. If the *MOVX* is displaying a grid or sequential log, the **ESC** key toggles the display options: Digits, RF, RECT, and B-Scan views.



3.16 Arrow Keys

The **Arrow Keys** are used to navigate through the menus, increase/decrease values, and toggle specific function keys.

3.17 ENTER key



The **ENTER** key is used in the overall menu selection process, to activate list and edit boxes, display and save measurements to grid file location.

3.18 MULTI MODE Key



The **MULTI MODE** key opens a measurement mode screen that lists all the modes available for the transducer selected. The two modes available are pulse-echo (P-E) and echo-echo (E-E). The high damped transducers will offer both modes, while the majority will only offer pulse-echo. An additional menu item “**capture To File**” is also available when pressing the MULTIMODE key. This allows a user to capture a screenshot of any measurement screen, menu, or list to a .tif file stored on the internal SD card.

3.19 ON/OFF Key



The **ON/OFF** key simply powers the unit either **ON** or **OFF**.

Note: *Unit will automatically power off when idle for 5 minutes. All current settings are automatically saved prior to powering off.*

3.20 Top & Bottom End Caps

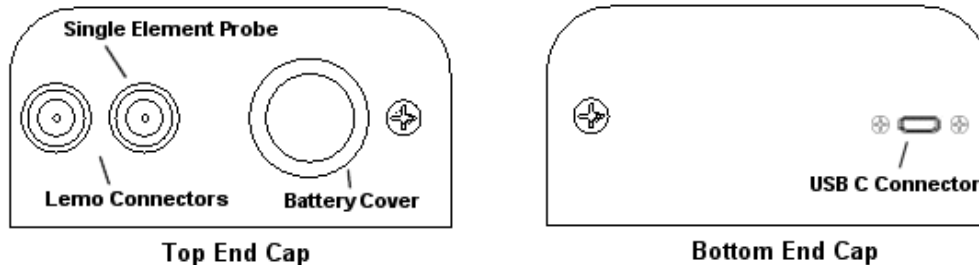

The top & bottom end panels are where all connections are made to the **MVX**. The diagram above shows the layout and description of the connectors:

Transducer Connectors

Refer to Diagram: The transducer connectors and battery cover/probe zero disk are located on the **MVX** top end cap. The transducer connectors are of type Lemo “00”.

Note: *There is no polarity associated with connecting the transducer to the **MVX**.*

Probe Zero Disk & Battery Cover

Refer to Diagram: The Battery cover is the large round disk shown in the diagram.

Note: This same disk is also used as a probe zero disk. Simply remove the cover when replacing the batteries (3 AA cells). When performing a manual probe zero function, simply place the transducer on disk making firm contact. **Important:** Be sure to follow the polarity labels located on the back label of the **MVX**.

Note: *Rechargeable batteries can be used however they must be recharged outside of the unit in a stand-alone battery charger.*

USB-C Connector

Refer to Diagram: The **USB-C** connector, located on the bottom end cap, is a mini type C female connector. It is designed to connect directly from the **MVX** to a standard USB type A port on a PC. The cable supplied with the **MVX** is a USB type C to a USB type A (pt# N-003-0330).

Note: *This connector is also used to upgrade the **MVX** with the latest version of firmware.*

CHAPTER FOUR

PRINCIPALS OF ULTRASONIC MEASUREMENT

4.1 Time versus thickness relationship

Ultrasonic thickness measurements depend on measuring the length of time it takes for sound to travel through the material being tested. The ratio of the thickness versus the time is known as the sound velocity. In order to make accurate measurements, a sound velocity must be determined and entered into the instrument.

The accuracy of a thickness measurement therefore depends on having a consistent sound velocity. Some materials are not as consistent as others and accuracy will be marginal. For example, some cast materials are very granular and porous and as a result have inconsistent sound velocities.

While there are many different ultrasonic techniques to measure thickness, which will be discussed below, all of them rely on using the sound velocity to convert from time to thickness.

4.2 Suitability of materials

Ultrasonic thickness measurements rely on passing a sound wave through the material being measured. Not all materials are good at transmitting sound.

Ultrasonic thickness measurement is practical in a wide variety of materials including metals, plastics, and glass. Materials that are difficult include some cast materials, concrete, wood, fiberglass, and some rubber.

4.3 Range of measurement and accuracy

The overall measurement capabilities, based on the wide variety of materials, is determined by the consistency of the material being measured

The range of thickness that can be measured ultrasonically depends on the material as well as the technique being used and the type of transducer. Thickness measurements can be made from a minimum of 0.010 inch to 9.999" in steel.

However, the maximum attainable thickness is much less for more attenuative materials (materials that absorb sound).

Accuracy, is determined by how consistent the sound velocity is through the sound path being measured, and is a function of the overall thickness of the material. For example, the velocity in steel is typically within 0.5% while the velocity in cast iron can vary by 4%.

4.4 Couplant

All ultrasonic applications require some medium to couple the sound from the transducer to the test piece. Typically a high viscosity liquid is used as the medium. The sound frequencies used in ultrasonic thickness measurement do not travel

through air efficiently. By using a liquid couplant between the transducer and test piece the amount of ultrasound entering the test piece is much greater.

4.5 Temperature

Temperature has an effect on sound velocity. The higher the temperature, the slower sound travels in a material. High temperatures can also damage transducers and present a problem for various liquid couplants.

Since the sound velocity varies with temperature it is important to calibrate at the same temperature as the material being measured.

Normal temperature range

Most standard transducers will operate from 0°F to 180°F.

High temperature measurements

Special transducers and couplants are available for temperatures above 180°F up to 650°F with intermittent contact. It is necessary to cool the transducer, by submerging the transducer in water between readings, when measuring high temperatures.

Modes and temperature errors

In addition to errors caused by velocity changing with temperature, some modes (measurement techniques) are affected more than others. For example, dual element pulse-echo mode has larger errors due to changes in the temperature of the delay line. However, multi-echo techniques offer temperature compensation help to minimize these errors.

4.6 Measurement Modes

In this section we will discuss the different measurements modes the *MVX* is capable of operating in, the transducers required, and the reasons for using specific modes:

Pulse-Echo Mode (Flaw & Pit detection) – (P-E)

Pulse-echo mode measures from the initial pulse (sometimes referred to as an artificial zero) to the first echo (reflection). A manual probe zero can be performed while in this mode, by placing the transducer on the reference disk located at the top end cap of the *MVX* and selecting the 'zero transducer' option in the "PRB" menu.

Errors can result from surface coatings and temperature gradients in pulse-echo mode. Therefore, the zero process should be performed on a frequent basis.

This mode is commonly used to detect flaws and pits, as it only requires one reflection and adjustable gate to improve sensitivity when measuring heavily corroded metals.

V-Path Correction

Dual element delay line transducers have two piezoelectric elements mounted at an angle on one end of the delay line. One element is used for transmitting sound, while

the other element only receives sound. The two elements and their delay lines are packaged in a single housing but acoustically isolated from each other with a sound barrier. This allows the transducer the ability to achieve very high sensitivity for detecting small defects. Also, the surface of the test material does not have to be as flat in order to obtain good measurements.

Dual element transducers are normally used in pulse-echo mode for finding defects, and in echo-echo mode for through coating measurements.

Dual element delay line transducers are usable over a range of 0.025 inches to 20 inches depending on the material, frequency, and diameter.

A limitation of dual element delay-line transducers is the V shaped sound path. Because the sound travels from one element to another, the time versus thickness relationship is non-linear. Therefore, a correction table in the instruments software is used to compensate for this error.

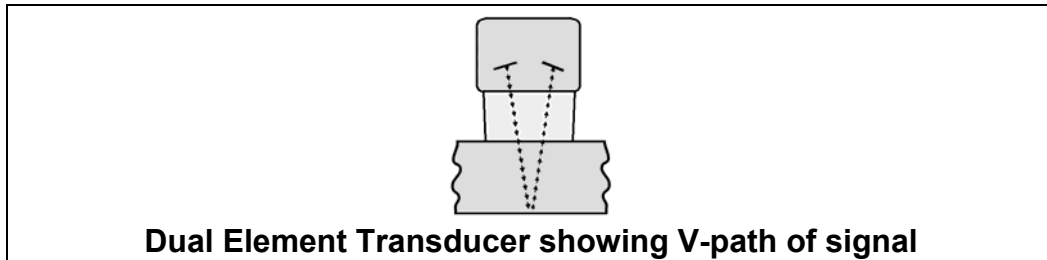

Searching for small defects

Dual element delay line transducers are especially useful in searching for small defects. In the pulse-echo mode with high amplifier gain, very small defects can be measured, and is useful during corrosion inspections to locate pits, porosity and cracks during tank and pipeline inspections, for example.

Echo-Echo Mode – Thru Coat (E-E)

The echo-echo mode measures between two reflections. This technique is commonly used to eliminate errors from surface coatings and applications with temperature gradients. The disadvantage is that two echoes are required for measurement. Certain materials can be difficult to pass sound through, making it hard to successfully achieve multiple echoes.

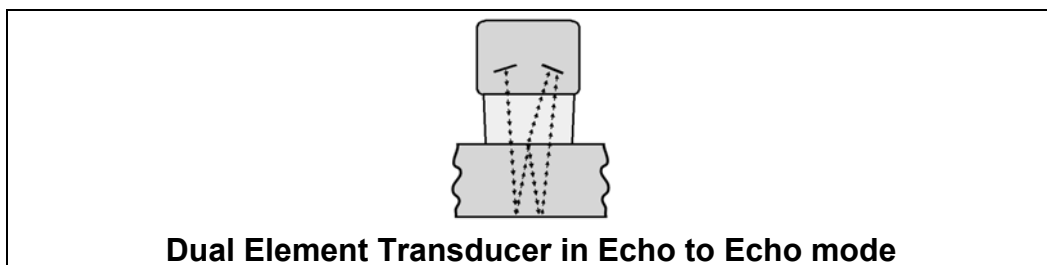

CHAPTER FIVE SELECTING THE MEASUREMENT MODE

5.1 The setup library

The *MVX* contains 64 user configurable preset locations to store custom setups for easy recall. These setups can be optimized for common application requirements, and bi-directionally transferred to the gauge and computer using Dakota's PC or OSX interface software, included with the instrument.

5.2 Which mode & transducer do I use for my application?

High penetration plastics and castings

The most common mode for these types of applications is pulse-echo. The *MVX* has been optimized for cast materials. Cast iron applications require 1 - 5MHz frequencies, and cast aluminum requires a 10MHz frequency. Plastics typically require lower frequencies depending on the thickness and make-up of the material. Larger diameters offer greater penetration power because of the crystal size, for difficult to measure materials.

Corrosion & Pit Detection in steel and cast materials

Use pulse-echo mode whenever attempting to locate pits and flaws. Typically a 5MHz transducer, or higher, will be used for these types of applications. Use low frequencies for greater penetration and use higher frequencies for better resolution.

Thru Paint & Coatings

Often times, users will be faced with applications where the material will be coated with paint or some other type of epoxy material. Since the velocity of the coating is approximately 2.5 times slower than that of steel, pulse-echo mode will induce error if the coating or paint is not completely removed. By using echo-echo mode, the user is able to successfully measure through both, the coating and steel, and completely eliminate the thickness of the paint or coating. Therefore, the steel can be measured without having to remove the coating prior to measuring. Users will often use pulse-echo mode and echo-echo mode in conjunction when performing inspections on coated materials.

Thru coating measurements require special high damped transducers. The most common transducers are the 3.5, 5, and 7.5MHz hi damped transducers. These transducers are suitable for use in both pulse-echo and echo-echo modes. This conveniently enables the user to accurately measure overall material thickness using the thru Coating mode, and then conveniently switch to pit detection mode without changing transducers.

Thin materials

Use pulse echo mode and a high frequency transducer for these types of applications. The most common transducers are the 7.5MHz and 10MHz models with extra resolution. The higher frequencies provide greater resolution and a lower minimum thickness rating overall.

High temperature

Use and select a special 2.25MHz and 5 MHz High temperature transducer for these types of applications. Both pulse-echo and echo-echo modes will also work for these applications. However, echo-echo mode will eliminate error caused by temperature variations in the delay line of the transducer.

Noisy Material

Materials such as titanium, stainless steel, and aluminum may have inherent surface noise issues. This is a signal that appears at the surface of the material when using a dual element delay line probe. Select a higher frequency transducer to reduce this noise – 7.5MHz and higher for better resolution.

Restricted access

Measuring materials with extreme curvatures or restricted access, higher frequencies with smaller diameters should be considered. The smallest diameter uses 3/16” crystals with a contact area of .250”. Custom transducers are available on request.

5.3 Factory Setup Chart

Num	Name	Comment 1	Gn/AGC	Velocity
1	Enter Custom Name			
2	...			
3	...			
4	...			
5	...			
6	...			
...	...			

CHAPTER SIX MAKING MEASUREMENTS

6.1 Selecting the Transducer Type

The first step in using the **MVX** is to plug the transducer into the gauge and power up the unit to display the main measurement screen. The diameter and frequency should be noted in order to select a transducer from the list of probes in the gauge. The steps to select a transducer are outlined below:

Note: *Once the transducer has been selected, the **MVX** will store and recall this transducer type every time the **MVX** is powered on/off. The type will only change if the user physically selects another type from the list, or selects a previously stored setup. Therefore, if you have previously gone through this section and selected the transducer you are using, proceed to the next section.*

Selecting the Transducer

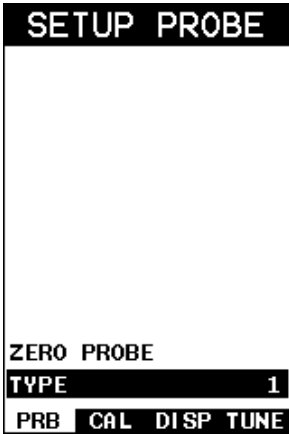

```
SETUP PROBE
ZERO PROBE
TYPE 1
PRB CAL DISP TUNE
```

- 1) Press the **MENU** key once to activate the menu items tab. Press the **MENU** key multiple times to tab right and the **ESC** key multiple times to tab left until the **PRB** menu is highlighted and displaying the submenu items.
- 2) Press the **UP** and **DOWN** arrow keys to scroll through the sub menu items until **TYPE** is highlighted.

PROBE TYPE	
1.	3/16IN - 5.0MHZ
2.	3/16IN - 7.5MHZ
3.	3/16IN - 10.0MHZ
4.	1/4IN - 2.25MHZ
5.	1/4IN - 5.0MHZ
6.	1/4IN - 5.0MHZ HD
7.	1/4IN - 7.5MHZ
8.	1/4IN - 7.5MHZ HD
9.	1/4IN - 10.0MHZ
10.	1/2IN - 1.0MHZ
11.	1/2IN - 1.0MHZ CP2T
12.	1/2IN - 2.25MHZ
13.	1/2IN - 2.25MHZ CP2T
14.	1/2IN - 3.5MHZ HD
15.	1/2IN - 5.0MHZ
16.	1/2IN - 7.5MHZ

- 3) Press the **ENTER** key to display the list of transducer options.
- 4) Press the **UP** and **DOWN** arrow keys to scroll through the transducer list until the appropriate type is highlighted.

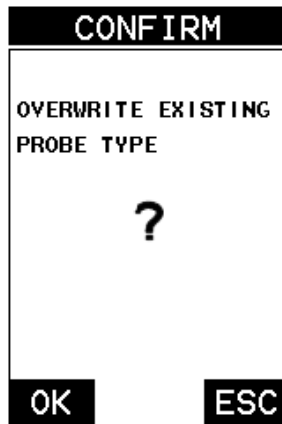

- 5) Press the **ENTER** key to select the transducer type and display overwrite confirmation screen.
- 6) Press the **OK** key to overwrite the existing probe type with the newly selected type.



7) The zero probe warning screen will be displayed. Press the **OK** key, followed by pressing the **MEAS** key to return to the main measurement screen and proceed to the probe zero section that follows.

6.2 Probe zero

The next step is to perform a probe zero. This must be done prior to calibration, and periodically performed during an inspection to account for temperature variations. If the **MVX** is not zeroed correctly, all measurements may be in error by some fixed value. In order to perform a zero, the gauge must be set to pulse-echo measurement mode. If the **MVX** is currently set to echo-echo mode, the menu item “transducer zero” will be grayed out and inactive.

The procedure to perform a zero is outlined below:

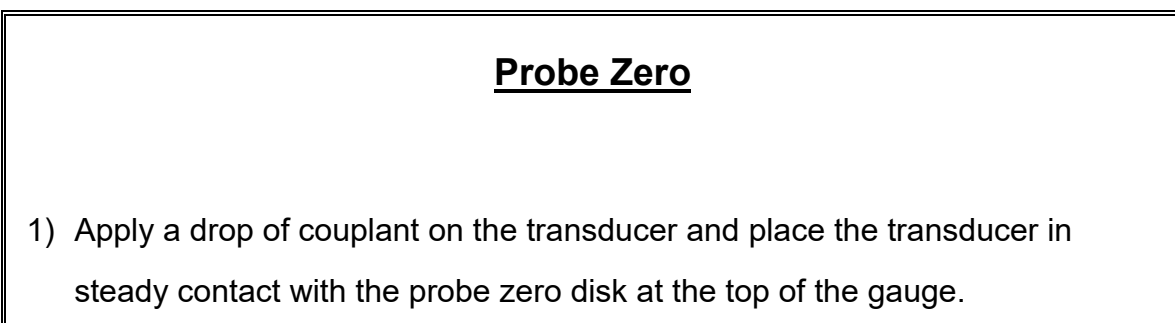

Probe Zero

1) Apply a drop of couplant on the transducer and place the transducer in steady contact with the probe zero disk at the top of the gauge.

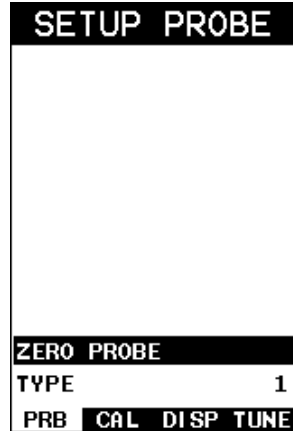

- 2) Press the **MENU** key once to activate the menu items tab. Press the **MENU** key multiple times to tab right and the **ESC** key multiple times to tab left until the **PRB** menu is highlighted and displaying the submenu items.
- 3) Press the **UP** and **DOWN** arrow keys to scroll through the sub menu items until **ZERO PROBE** is highlighted.

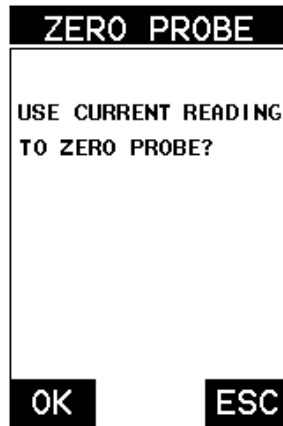

- 4) Press the **ENTER** key to display the confirmation screen.
- 5) Press the **OK** key to perform the zero, or **ESC** key to cancel the probe zero process.
- 6) Proceed to the calibration section.

Note: *The value that is displayed will change depending on the current velocity setting in the **MVX**. Disregard the number that is displayed. **It is not***

important. What is important is accurately performing the steps outlined above to insure reliability of the probe zero calculation.

6.3 Material Calibration

In order for the **MVX** to make accurate measurements, it must be set to the correct sound velocity of the material being measured. Sound will travel at different speeds in different material types. For example, the velocity of sound through steel is about 0.233 inches per microsecond, versus that of aluminum, which is about 0.248 inches per microsecond. If the gauge is not set to the correct sound velocity, all of the measurements the gauge makes will be erroneous by some fixed percentage.

The **One Point** calibration is the simplest and most commonly used calibration method - optimizing linearity over large ranges. The **Two Point** calibration allows for greater accuracy over small ranges by calculating the probe zero and velocity. The **MVX** provides four simple methods for setting the sound-velocity outlined below:

Known Velocity

If the material velocity is known, the user may wish to simply enter the velocity number into the **MVX**, rather than have the **MVX** calculate the velocity value using a known thickness on a material sample. The steps for entering the velocity are outlined below:

Using a Known Material Velocity

CALIBRATE

MAT STEEL <4340>
 MATL 1PT UNCAL
 MATL 2PT UNCAL
VELOCITY 0.2330
PRB CAL DISP TUNE

- 1) Press the **MENU** key once to activate the menu items tab. Press the **MENU** key multiple times to tab right and the **ESC** key multiple times to tab left until the **CAL** menu is highlighted and displaying the submenu items.
- 2) Use the **UP** and **DOWN** arrow keys to scroll through the sub menu items until **VELOCITY** is highlighted.



- 3) Press the **ENTER** key to display the **Digits Edit Box**.
- 4) Press the **UP** and **DOWN** arrow keys to scroll the highlighted value.
- 5) Press the **LEFT** and **RIGHT** arrow keys to scroll the digit locations.
- 6) Repeat steps **4 & 5** until the velocity number is correctly displayed.
- 7) Press the **OK** key to set the velocity and return to the menu screen, or **ESC** to cancel entering the velocity.
- 8) Finally, press the **MEAS** key to return to the measurement screen and begin taking readings.

Known Thickness

Often times the sound velocity of a material is unknown. In this case a sample with one or two known thicknesses can be used to determine the sound velocity. As previously discussed, the **MVX** has a one or two point calibration option. The one point calibration option is most suited for linearity over large ranges, as noted above. The user should also consider calibrating on high side of the intended measurement range, when using the one point option, minimize overall error. For example, if the measurement range is .100" (2.54mm) to 1.0" (25.4mm), the user should calibrate on a known thickness sample close to 1.0" (25.4mm).

Note: *It's always handy to carry a set of mechanical calipers to use in conjunction with the **MVX** for calibration in the field.*

One Point Calibration

CALIBRATE	
MAT	STEEL <4340>
MATL 1PT	UNCAL
MATL 2PT	UNCAL
VELOCITY	0.2330
PRB	CAL DISP TUNE

Note: *Be sure that the probe zero has been performed prior to performing this procedure.*

- 1) Physically measure an exact sample of the material, or a location directly on the material, to be measured using a set of calipers or a digital micrometer.
- 2) Apply a drop of couplant on the transducer and place the transducer in steady contact with the sample or actual test material. Be sure that the reading is stable and the repeatability indicator, in the top left corner of the display, is fully lit and stable. Press the **MENU** key once to activate the menu items tab. Press the **MENU** key multiple times to tab right and the

ESC key multiple times to tab left until the **CAL** menu is highlighted and displaying the submenu items.

- 3) Use the **UP** and **DOWN** arrow keys to scroll through the sub menu items until **MATL 1PT** is highlighted.



- 4) Press the **ENTER** key to display the **Digits Edit Box**.
- 5) Press the **UP** and **DOWN** arrow keys to scroll the highlighted value.
- 6) Press the **LEFT** and **RIGHT** arrow keys to scroll the digit locations.
- 7) Repeat steps **5 & 6** until the known thickness value is correctly displayed.
- 8) Press the **OK** key to calculate the velocity and return to the menu screen, or **ESC** to cancel the one point calibration.
- 9) Finally, press the **MEAS** key to return to the measurement screen and begin taking readings.

Note: CHECK YOUR CALIBRATION! Place the transducer back on the calibration point. The thickness reading should now match the known thickness. If the thickness is not correct, repeat the steps above.

At some point there may become a requirement for improved accuracy over a smaller measurement range. In this case, a two point calibration would be most suited for the job. For example, if the measurement range was .080" (2.03mm) to .250" (6.35mm), the user would perform a one point calibration on a known thickness

sample close to .250" (6.35mm), followed by a two point calibration close to .080" (2.03mm). When a two point calibration is performed, the **MX** calculates the zero and the velocity. The following steps outline this procedure:

Two Point Calibration

CALIBRATE	
MAT	STEEL <4340>
MATL 1PT	UNCAL
MATL 2PT	UNCAL
VELOCITY	0.2330
PRB	CAL DISP TUNE

- 1) Physically measure an exact sample of the material or a location directly on the material to be measured using a set of calipers or a digital micrometer.
- 2) Apply a drop of couplant on the transducer and place the transducer in steady contact with the sample or actual test material. Be sure that the reading is stable and the repeatability indicator, in the top left corner of the display, is fully lit and stable. Press the **MENU** key once to activate the menu items tab. Press the **MENU** key multiple times to tab right and the **ESC** key multiple times to tab left until the **CAL** menu is highlighted and displaying the submenu items.
- 3) Use the **UP** and **DOWN** arrow keys to scroll through the sub menu items until **MATL 2PT** is highlighted.

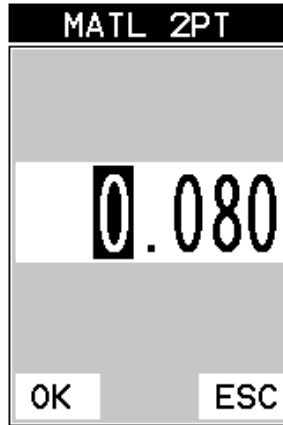

- 4) Press the **ENTER** key to display the **Digits Edit Box**.
- 5) Press the **UP** and **DOWN** arrow keys to scroll the highlighted value.
- 6) Press the **LEFT** and **RIGHT** arrow keys to scroll the digit locations.
- 7) Repeat steps **5 & 6** until the known thickness value is correctly displayed.
- 8) Press the **OK** key to calculate the velocity and return to the menu screen, or **ESC** to cancel the one point calibration.
- 9) Finally, press the **MEAS** key to return to the measurement screen and begin taking readings.

Note: ***CHECK YOUR CALIBRATION!** Place the transducer back on the calibration point. The thickness reading should now match the known thickness. If the thickness is not correct, repeat the steps above.*

Basic Material Type

If the material velocity is unknown, and a sample thickness cannot be taken from the material, the user may opt to choose a basic material type from a list with approximate velocity values according to various material types. It's important to note that these velocities will not always be an exact representation of the material being tested. Use these values only if a close approximation is acceptable. Follow the steps below to select a basic material type:

Selecting a Basic Material Type

CALIBRATE	
MAT	STEEL <4340>
MATL 1PT	UNCAL
MATL 2PT	UNCAL
VELOCITY	0.2330
PRB	CAL DISP TUNE

- 1) Press the **MENU** key once to activate the menu items tab. Press the **MENU** key multiple times to tab right and the **ESC** key multiple times to tab left until the **CAL** menu is highlighted and displaying the submenu items.
- 2) Use the **UP** and **DOWN** arrow keys to scroll through the sub menu items until **MAT** is highlighted.

MATL TYPE	
18. MONEL	0.2110
19. NICKEL	0.2220
20. NYLON	0.1060
21. PLATINUM	0.1560
22. PLEXIGLASS	0.1060
23. POLYSTYRENE	0.0920
24. PVC	0.0940
25. QUARTZ GLASS	0.2260
26. RUBBER, VULCAN	0.0910
27. SILVER	0.1420
28. STEEL <1020>	0.2320
29. STEEL <4340>	0.2330
30. STEEL, STAIN.	0.2230
31. TEFLON	0.0540
32. TIN	0.1310
33. TITANIUM	0.2400
34. TUNGSTEN	0.2040

- 3) Press the **ENTER** key to display the list of material types.
- 4) Press the **UP** and **DOWN** arrow keys to scroll through the material list until the appropriate material is highlighted.

```
CALIBRATE  
  
MAT STEEL <4340>  
MATL 1PT UNCAL  
MATL 2PT UNCAL  
VELOCITY 0.2330  
PRB CAL DISP TUNE
```

- 5) Press the **ENTER** key to overwrite the material type and display the menu items with the new material type selected.
- 6) Finally, press the **MEAS** key to return to the measurement screen and begin taking readings.

CHAPTER SEVEN USING THE DISPLAY OPTIONS

A key feature of the **MVX** is the ability to toggle between four different display options; Digits, RF, RECT and B-Scan. All views provide a digital readout of the base material thickness measurement, while also displaying the min/max values if scan is enabled. A key feature of the **MVX** is the waveform display. The waveform is a graphical representation of the sound reflections returning to the transducer. Consider standing at the base of a canyon and screaming "Hello There". After a brief delay, you will here multiple echoes, "Hello There's" repeated back to you. The waveform display shows the amplitude of the signal received on the vertical (Y) axis and time (shown in units of thickness) on the horizontal (X) axis. The waveform display is very useful for viewing and adjusting the location of the gates. The gates are typically used to eliminate potential surface noise by adjusting the starting point in single echo modes, for multi echo measurement modes, as well as to adjust the threshold (sensitivity) in either mode. The waveform display is also very useful for locating pits and internal flaws in materials.

The B-Scan display is also very useful when scanning surfaces and viewing the cross section of the test material. It provides a convenient way of visually profiling, or drawing a picture of, the blind surfaces during a scan. The B-Scan display is also equipped with a scan bar representing the overall thickness. The scan bar gives the user a visual indication when a flaw or defect passed over during the scan process. The scan bar will deflect off of the defect and return back to the overall thickness. Visually, this is much easier to notice than watching for changes in the digital value displayed. The scan bar has also been included in the large digits display mode for the same purpose.

Note: *The following chapter outlines some of the fine adjustment features of the **MVX**. The **MVX** has four different display options (**RF A-Scan, Rectified A-Scan, B-Scan, and Large Digits**). We'll take a better look at these options in this chapter.*

Note: *In order to recall and use the new adjustments made to the **MVX** at a later time, the user must save the modified settings in one of the setup locations prior to powering off the unit. Refer page 111 for more information on setups.*

7.1 Display Views

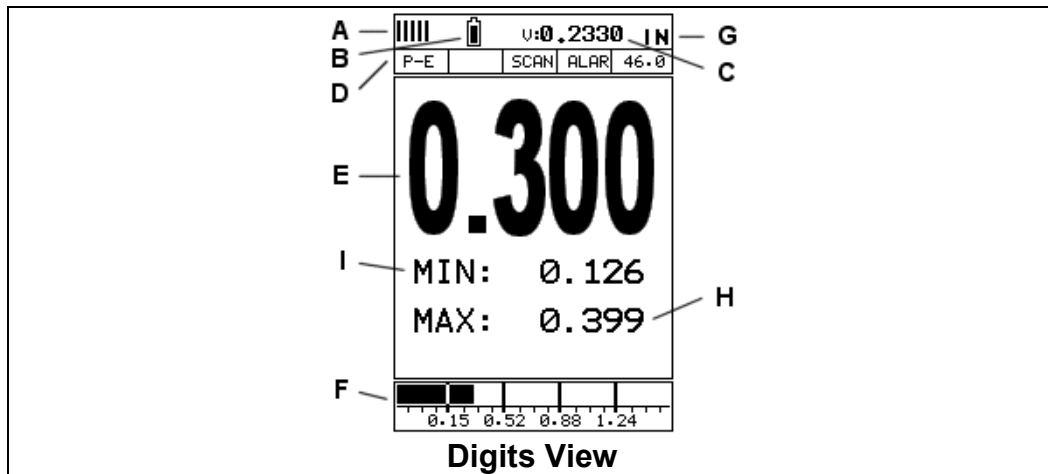

Digits

The Digits view is a basic digital thickness gauge look and feel. The larger digits make it much easier for the operator to monitor the thickness readings. The Scan Bar has also been added to the Digits view to provide the user with yet another visual tool for easily monitoring changes in thickness readings due to internal flaws or defects.

The following is a list of the viewable features on the display:

- A. **Repeatability/Stability Indicator** – This indicator should be commonly used in conjunction with the digital thickness values displayed. When all the vertical bars are fully illuminated and the last digit on the digital thickness value is stable, the *MVX* is reliably measuring the same value 250 times per second, depending on which measurement mode and features are enabled.
- B. **Battery Icon** – Indicates the amount of battery life the *MVX* has remaining.
- C. **Velocity** – The material velocity value the *MVX* is currently using or calibrated for. Displayed in English or Metric units, depending on what units the gauge is set for.
- D. **Feature Status Bar** – Indicates the features currently enabled and in use in the following order:
 - Measurement Mode (P-E, E-E)
 - Differential Mode (ON/OFF)
 - High Speed Scan Mode (ON/OFF)
 - Alarm Mode (ON/OFF/AUDIBLE)
 - Gain Setting (10 to 56 dB)

- E. **Digital Material Thickness Value** – Extra large font size for viewing ease.
- F. **Scan Bar** – Another view of material thickness in a deflection style horizontal bar. This is another visual tool that would enable the user the ability to see thickness changes during high speed scans from flaws and pits.
- G. **Units** – The current measurement units being used (English, Metric).
- H. **Minimum Material Thickness** – Part of the scan feature. Displays the minimum thickness value found during a scan.
- I. **Maximum Material Thickness** – Part of the scan feature. Displays the maximum thickness value found during a scan.

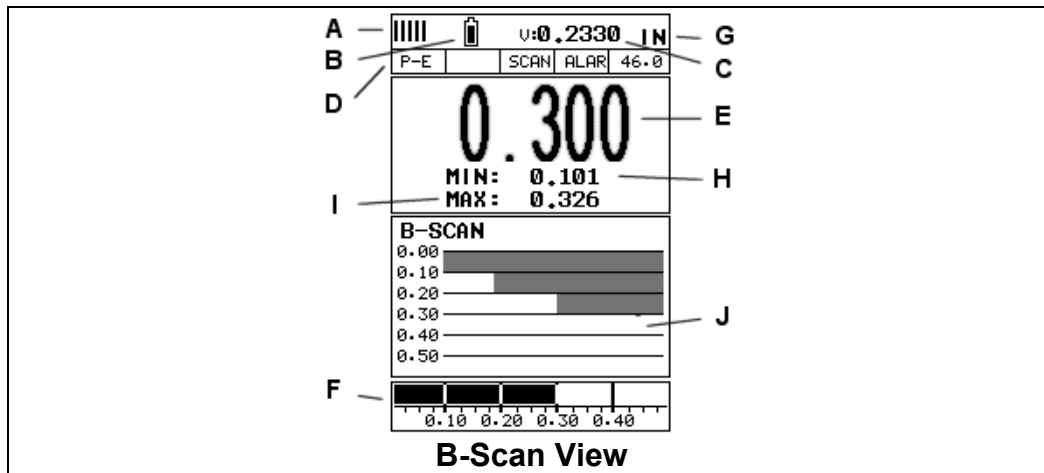

B-Scan

The B-Scan displays a time based cross section view of test material. This view is commonly used to display the contour of the blind, or underside, surface of a pipe or tank application. It is very similar to a fish finder. If a flaw or pit is located during a scan, the B-Scan will draw the pit on the screen. The solid black rectangle in the diagram at location K represents the cross section, or side view of the material. The B-Scan view draws at a rate of 7 seconds per screen from right to left. Also notice at location K, the pits and corroded bottom surface of the material.

It's important to note that the measurement range on the display be set wide enough, so that the maximum thickness of the material can be viewed on the display. Using the diagram above, if the material thickness was actually 1.75", the underside of the material would not be viewable according to the current range at 0.00" – 1.00". All the user would see is a black screen from 0.00" – 1.00" with no view of the bottom contour at 1.75".

The following is a list of the viewable features on the display:

- A. **Repeatability/Stability Indicator** – This indicator should be commonly used in conjunction with the digital thickness values displayed. When all the vertical

bars are fully illuminated and the last digit on the digital thickness value is stable, the **MVX** is reliably measuring the same value 250 times per second, depending on which measurement mode and features are enabled.

- B. **Battery Icon** – Indicates the amount of battery life the **MVX** has remaining.
- C. **Velocity** – The material velocity value the **MVX** is currently using or calibrated for. Displayed in either English or Metric units, depending on what units the gauge is set for.
- D. **Feature Status Bar** – Indicates the features currently enabled and in use in the following order:
 - Measurement Mode (P-E, E-E)
 - Differential Mode (ON/OFF)
 - High Speed Scan Mode (ON/OFF)
 - Alarm Mode (ON/OFF/AUDIBLE)
 - Gain Setting (10 to 56 dB)
- E. **Digital Material Thickness Value** – Smaller font size when the B-Scan display view is enabled.
- F. **Scan Bar** – Another view of material thickness in a deflection style horizontal bar. This is another visual tool that would enable the user the ability to see thickness changes during high speed scans from flaws and pits.
- G. **Units** – The current measurement units being used (English, Metric).
- H. **Minimum Material Thickness** – Part of the scan feature. Displays the minimum thickness value found during a scan.
- I. **Maximum Material Thickness** – Part of the scan feature. Displays the maximum thickness value found during a scan.
- J. **B-Scan Display** – Cross section view of the material. Provides the user with graphical view of the opposite/blind surface (i.e. inside pipe wall surface), to give the user some idea of the condition, or integrity of the material being tested.

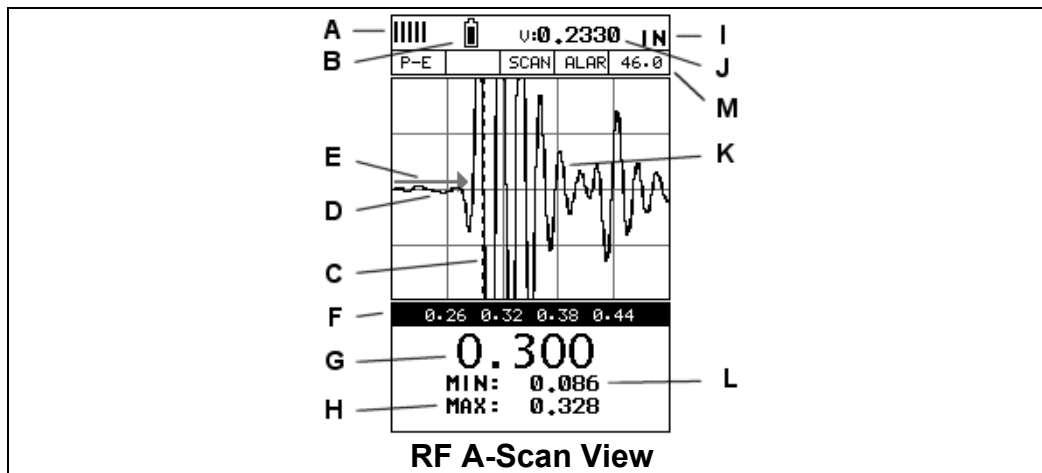

Radio Frequency (RF) A-Scan

The RF mode shows the waveform in a similar fashion to an oscilloscope. It shows both the positive and the negative peaks. The peak (either positive or negative) selected for measurement is shown in upper portion of the display.

It's important to note that a measurement must fall inside the displays viewable range in order to see the waveform. However, even if the waveform is outside of the viewable range of the display, a measurement can be taken and viewed on the digital readout. If the wave is outside of the display range, you can manually change the range by adjusting the **Delay** and **Range** values, or you can use the **Auto Find** feature located in the **UTIL** menu of the tabbed menu items. Refer to page 76 for additional information on the **Auto Find** feature.

The following is a list of the viewable features on the display:

- A. **Repeatability/Stability Indicator** – This indicator should be commonly used in conjunction with the digital thickness values displayed. When all the vertical bars are fully illuminated and the last digit on the digital thickness value is stable, the **MVX** is reliably measuring the same value 3 to 200 times per second, depending on which measurement mode and features are enabled.
- B. **Battery Icon** – Indicates the amount of battery life the **MVX** has remaining.
- C. **Detect Indicator** – The broken vertical line displays the zero crossing (flank) detection point on the waveform where the measurement has been obtained. Notice that the digital thickness readout is the same as the location of the detect indicator according to the measurements labels F, also in the diagram.
- D. **Baseline** - The horizontal trace across the A-scan presentation for a no signal condition. It represents time and is generally related to material distance or thickness.
- E. **Gate** – An electronic feature that allows the user to monitor signals inside the boundaries of the gate settings. The height of the gate from the baseline is

known as the threshold, and controls the sensitivity of the reflections that trigger a detection from the opposite surface of the material.

- F. **Measurement Scale** – Represents thickness values over a defined measurement range, and labeled at the calibrated hash marks on the display (X) axis.
- G. **Digital Material Thickness Value** – The thickness of the base material.
- H. **Maximum Thickness Value** – Dynamically updates the value during a scan, and displays the maximum thickness value found. Note: Only visible when high speed scan mode is enabled.
- I. **Units** – The current measurement units being used (English, Metric).
- J. **Velocity** – The material velocity value the **MVX** is currently using or calibrated for. Displayed in either English or Metric units, depending on what units the gauge is set for.
- K. **RF waveform** – The sine wave created by the reflected sound, or oscillation, from the material being measured. The both the positive and negative half cycles (full cycles) are displayed.
- L. **Minimum Thickness Value** – Dynamically updates the value during a scan, and displays the minimum thickness value found. Note: Only visible when high speed scan mode is enabled.
- M. **Feature Status Bar** - Indicates the features currently enabled and in use in the following order:
 - Measurement Mode (P-E, E-E)
 - Differential Mode (ON/OFF)
 - High Speed Scan Mode (ON/OFF)
 - Alarm Mode (ON/OFF/AUDIBLE)
 - Gain Setting (10 to 56 dB)

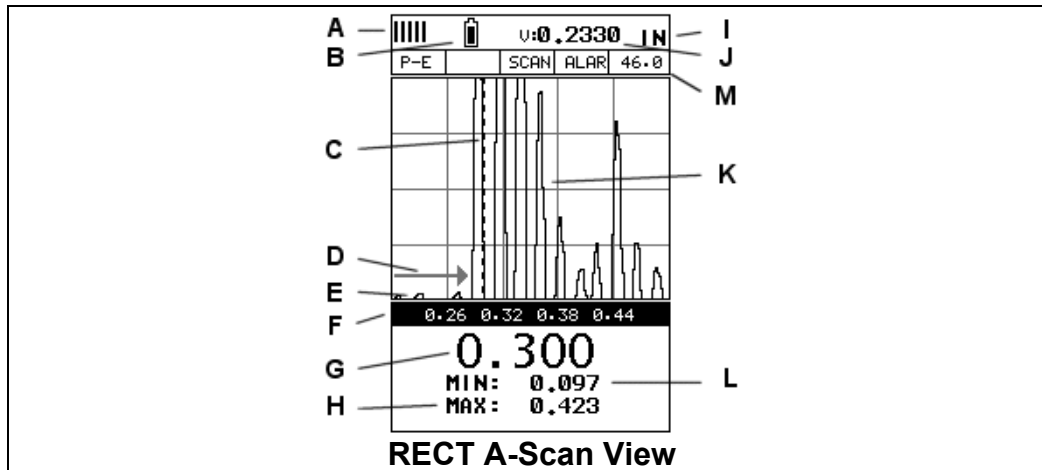

Rectified (RECT) A-Scan

The RF mode shows the waveform in a similar fashion to an oscilloscope. It shows both the positive and the negative peaks. The peak (either positive or negative) selected for measurement is shown in upper portion of the display.

It's important to note that a measurement must fall inside the displays viewable range in order to see the waveform. However, even if the waveform is outside of the viewable range of the display, a measurement can be taken and viewed on the digital readout. If the wave is outside of the display range, you can manually change the range by adjusting the **Delay** and **Range** values, or you can use the **Auto Find** feature located in the **UTIL** menu of the tabbed menu items. Refer to page 76 for additional information on the **Auto Find** feature.

The following is a list of the viewable features on the display:

- A. **Repeatability/Stability Indicator** – This indicator should be commonly used in conjunction with the digital thickness values displayed. When all the vertical bars are fully illuminated and the last digit on the digital thickness value is stable, the **MVX** is reliably measuring the same value 3 to 200 times per second, depending on which measurement mode and features are enabled.
- B. **Battery Icon** – Indicates the amount of battery life the **MVX** has remaining.
- C. **Detect Indicator** – The broken vertical line displays the zero crossing (flank) detection point on the waveform where the measurement has been obtained. Notice that the digital thickness readout is the same as the location of the detect indicator according to the measurements labels F, also in the diagram.
- D. **Gate** – An electronic feature that allows the user to monitor signals inside the boundaries of the gate settings. The height of the gate from the baseline is known as the threshold, and controls the sensitivity of the reflections that trigger a detection from the opposite surface of the material.

- E. **Baseline** - The horizontal trace across the A-scan presentation for a no signal condition. It represents time and is generally related to material distance or thickness.
- F. **Measurement Scale** – Represents thickness values over a defined measurement range, and labeled at the calibrated hash marks on the display (X) axis.
- G. **Digital Material Thickness Value** – The thickness of the base material.
- H. **Maximum Thickness Value** – Dynamically updates the value during a scan, and displays the maximum thickness value found. Note: Only visible when high speed scan mode is enabled.
- I. **Units** – The current measurement units being used (English, Metric).
- J. **Velocity** – The material velocity value the **MVX** is currently using or calibrated for. Displayed in either English or Metric units, depending on what units the gauge is set for.
- K. **RECT waveform** – The half cycle, either positive or negative, of the RF sine wave, created by the reflected sound, or oscillation, from the material being measured. This view is typically considered as “flaw” view.
- L. **Minimum Thickness Value** – Dynamically updates the value during a scan, and displays the minimum thickness value found. Note: Only visible when high speed scan mode is enabled.
- M. **Feature Status Bar** - Indicates the features currently enabled and in use in the following order:
- Measurement Mode (P-E, E-E)
 - Differential Mode (ON/OFF)
 - High Speed Scan Mode (ON/OFF)
 - Alarm Mode (ON/OFF/AUDIBLE)
 - Gain Setting (10 to 56 dB)

7.2 Changing Display Options

The following procedure outlines how to select or toggle display options:

Display Views

SET DISPLAY	
VIEW	RF
DELAY	0.086
RANGE	0.229
UNITS	IN
BACKLIGHT	OFF
CONTRAST	10
RECT WAVE	OUTLINE
DETECT MARK	DOTS
PRB	CAL
DISP	TUNE

- 1) Press the **MENU** key once to activate the menu items tab. Press the **MENU** key multiple times to tab right, and the **ESC** key multiple times to tab left, until the **DISP** menu is highlighted and displaying the submenu items.
- 2) Use the **UP** and **DOWN** arrow keys to scroll through the sub menu items until **VIEW** is highlighted.
- 3) Use the **LEFT** and **RIGHT** arrow keys to scroll the view options. Once the appropriate view is displayed, press the **MEAS** key to return to the measurement screen and begin taking measurements.

7.3 Adjusting the display

This section will cover the procedures for adjusting the viewable range, or area, of the display, in terms of thickness. A basic overview of this section would be as follows: Suppose we had a 50" widescreen television set. The left side of the television screen is considered the **Delay** for all view options other than B-Scan. In B-Scan view, it's called **B-Start**. Therefore, **Delay (B-Start)** are *identical*, with the

exception of the terminology used, and represent the left side of the television screen.

The right side of the television screen is considered the **Range + Delay**, in all view options with the exception of B-Scan, once again. In B-Scan view, it would be considered **B-Depth + B-Start**. Therefore, the following should be considered: **Delay (B-Start) + Range (B-Depth) = right side of the screen**, depending on what view option is active.

Now, by adjusting the left and right side of the television screen, to control the viewable area/range, we can zoom in and out of any part of the 50" screen we'd like, and focus on only the specific areas of the screen we need to. Therefore, if I am measuring a part, and am only interested in viewing the thickness range/area from .500" – 1.0", and I'd like to zoom in a bit to get a close up look at things, I'd set my Delay (B-Start) to .500" and my Range (B-Depth) to .500". This would make the left side of my screen start at .500", and the right side of the screen at 1.0".

Setting the Delay (B-Start)

The Delay (B-Start) represents the left side of the display, and can be adjusted to start at any thickness value within the overall range of the **MVX**. The value the Delay (B-Start) is set too, is the minimum thickness value that will be displayed on the screen.

Note: Once the delay is set, it will remain the same for the views: Digits, RF, RECT. However, in B-Scan view, the B-Start is an independent setting from Delay, and allow the user to store two independent settings respectively.

The procedures to adjust the **Delay (B-Start)** are outlined below:

Adjusting Delay (B-Start) using the Hot Menu

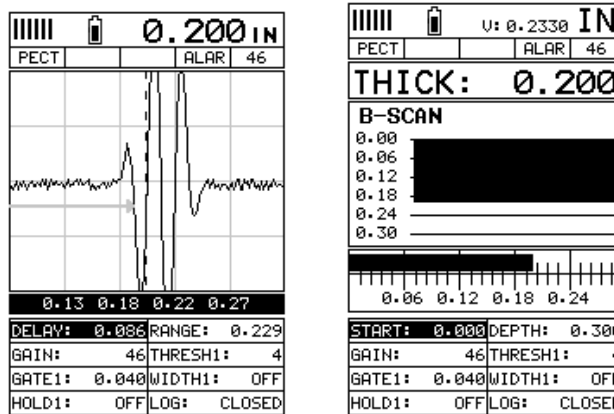

- 1) Press the **MEAS** key once to activate measure menu items. Press the **MEAS** key multiple times to move right and the **ESC** key multiple times to move left, until the **DELAY** cell is highlighted.
- 2) Press the **UP**, **DOWN**, **LEFT**, and **RIGHT** arrow keys to scroll the highlighted value.

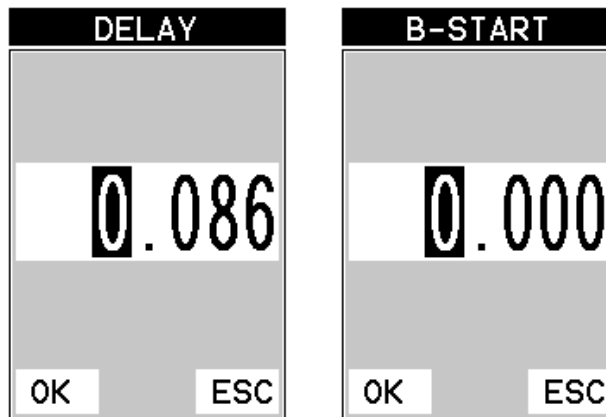

- 3) **Alternatively**, press the **ENTER** key to display the **Digits Edit Box**.
- 4) Press the **UP** and **DOWN** arrow keys to scroll the highlighted value.
- 5) Press the **LEFT** and **RIGHT** arrow keys to scroll the digit locations.
- 6) Repeat steps **4 & 5** until the **DELAY** value is correctly displayed.

- 7) Press the **OK** key to return to the measurement screen, or **ESC** to cancel entering the **DELAY**.
- 8) Finally, press the **MEAS** key to return to the measurement screen and begin taking readings.

Adjusting the Range (B-Depth)

Once again, just to reiterate, the **Range (B-Depth) + Delay (B-Start) equals the right side of the screen**. Therefore, the Range (B-Depth) is the overall area, from the delay, that will be viewable on the screen. The **MXV** digitizer will round up from the Range (B-Depth) that's entered. Therefore, if the Range (B-Depth) is set at 1.0", the digitizer will round this value up to the next adjustment available. The procedures to adjust the overall thickness range viewed Range (B-Depth) are outlined below:

Adjusting the Range (B-Depth) using the Hot Menu

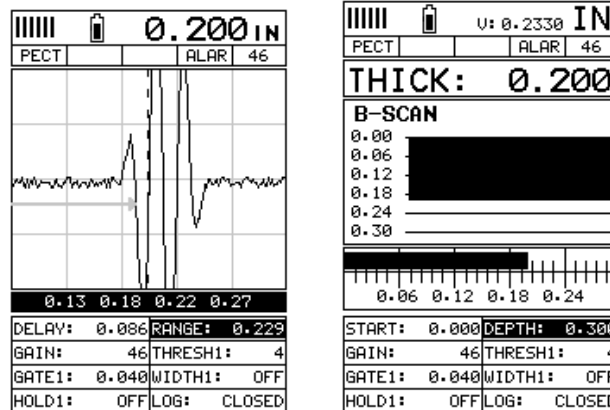

- 1) Press the **MEAS** key once to activate measure menu items. Press the **MEAS** key multiple times to move right and the **ESC** key multiple times to move left, until the **WIDTH** cell is highlighted.
- 2) Press the **UP**, **DOWN**, **LEFT**, and **RIGHT** arrow keys to scroll the highlighted value.

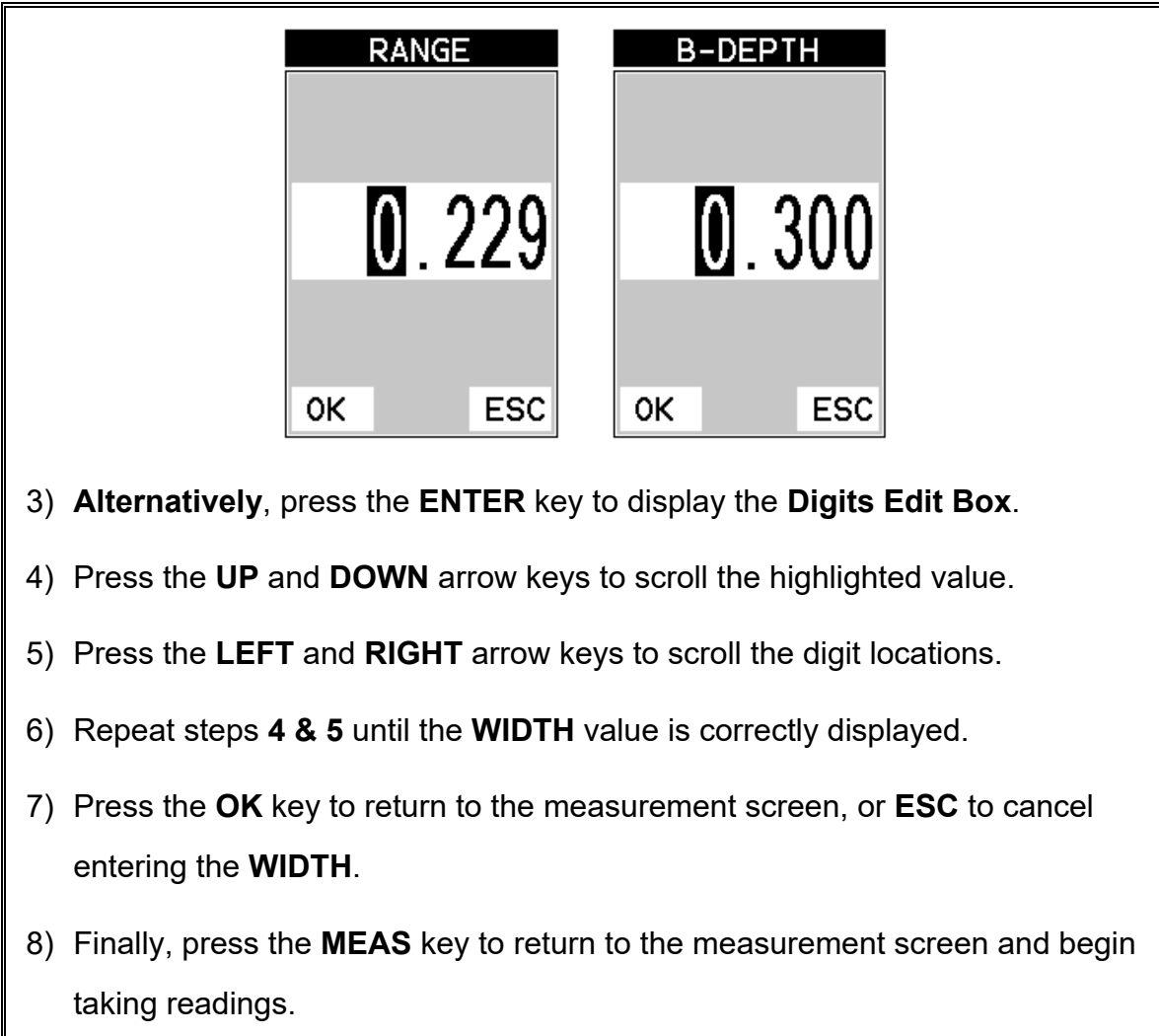

Adjusting the B-Scan Speed

The **MVX** has the capability to adjust the the scrolling speed of the time based B-Scan displayed in the gauge. The procedures to adjust the speed are outlined below:

Adjusting the B-Scan Speed

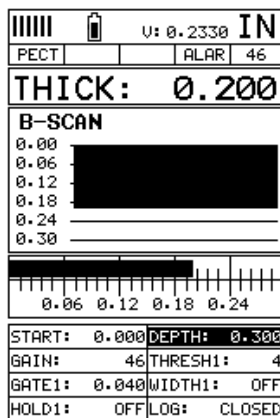

- 1) Press the **MENU** key once to activate the menu items tab. Press the **MENU** key multiple times to tab right, and the **ESC** key multiple times to tab left, until the **DISP** menu is highlighted and displaying the submenu items.
- 2) Use the **UP** and **DOWN** arrow keys to scroll through the sub menu items until **B-SCAN SPEED** is highlighted.
- 3) Use the **LEFT** and **RIGHT** arrow keys to scroll the speed from 0-10. Note: 10 representing the fastest scroll time. Once the appropriate speed is displayed, press the **MEAS** key to return to the measurement screen and begin the B-Scan process.
- 4) **Alternatively**, press the **ENTER** key to display the **Digits Edit Box**.
- 5) Press the **UP** and **DOWN** arrow keys to scroll the highlighted value.
- 6) Press the **LEFT** and **RIGHT** arrow keys to scroll the digit locations.
- 7) Repeat steps **5 & 6** until the **SPEED** is correctly displayed.

- 8) Press the **OK** key to set the speed and return to the **DISP** menu., followed by pressing the **MEAS** key to begin the B-Scan process.
- 9) Finally, press the **MEAS** key to return to the measurement screen and begin the scanning process.

7.4 Gain

The gain, or amplification of the return echoes, can be adjusted in the **MVX** to accommodate a variety of applications. The setting of the gain is crucial in order to obtain valid readings during the measurement process. Too much gain may result in erroneous measurements by detecting on noise rather than the actual material back wall itself. Not enough gain may result in intermittent detection. It may also result in lack of detection on internal flaws, pits, or porosity. The gain can easily be compared to the volume control of a home stereo system. If you turn it up too much, you can't hear the music clearly. If it's turned down too much, you can't hear it at all.

The **MVX** has a 50dB gain range (10 to 60 dB), for thickness gauge applications. The common starting point for standard thickness gauge applications is 46dB. This feature is used to increase/decrease the output or amplitude of the signal. The gain can be adjusted to accommodate a variety of material types. Having this feature available provides the user with a great deal of flexibility. Some applications may require the lower or higher gain settings. When? The low settings may be necessary for noisy or granular cast materials. How do I know when to lower the gain? If the reading becomes sporadic and won't settle down or resolve on a thickness value, the user can assume that the material is either very noisy aluminum, or granular cast iron. This would be a good time to change the **MVX** to lower gain setting and see if the reading settles down and becomes stable.

How do I know when to increase the gain? Often times the user will be trying to measure a material that is hard to penetrate or pass sound through. This may be due to the material type, or overall thickness of the material. When a material is hard to pass sound through because of the thickness or general make-up, it would be a good time to consider increasing the **MVX** to a higher gain setting. Another example might be the need to increase overall sensitivity for locating fine pits or flaws. In any case, the adjustable gain feature offers the user some additional options to resolve and overcome application issues.

Note: *When the echo-echo thru-paint, or echo-echo-verify measurement modes are selected, the manual gain feature is disabled and grayed out in the menu items. In*

this mode, the **MXV** switches to an automatic gain mode (**AGC**) that optimizes the gain setting automatically in the hardware of the **MXV**.

The procedures to adjust the **Gain** are outlined below:

Adjusting the Gain using the Hot Menu

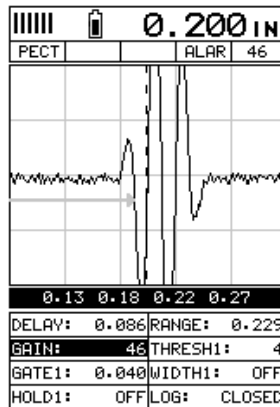

- 1) Press the **MEAS** key once to activate measure menu items. Press the **MEAS** key multiple times to move right, and the **ESC** key multiple times to move left until the **GAIN** cell is highlighted.
- 2) Press the **UP**, **DOWN**, **LEFT**, and **RIGHT** arrow keys to scroll the highlighted value.

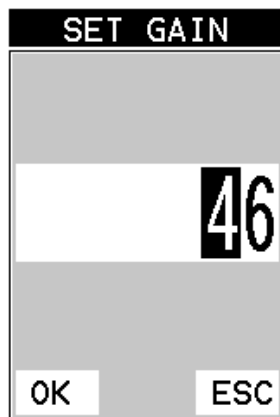

- 3) **Alternatively**, press the **ENTER** key to display the **Digits Edit Box**.
- 4) Press the **UP** and **DOWN** arrow keys to scroll the highlighted value.

- 5) Press the **LEFT** and **RIGHT** arrow keys to scroll the digit locations.
- 6) Repeat steps **4 & 5** until the **GAIN** value is correctly displayed.
- 7) Press the **OK** key to return to the measurement screen, or **ESC** to cancel entering the **GAIN**.

The user can also access and adjust the gain from the tabbed menus. However, this method is more tedious than making the adjustments using the **Hot Menu**. The procedure using the tabbed menu is outlined below:

Adjusting the Gain using the Tabbed Menu

TUNE SIGNAL	
MEASURE MODE	P-E
POLARITY	POSITIVE
PULSE	THIN
GAIN	46.0
AGC	21
PRB	CAL DISP TUNE

- 1) Press the **MENU** key once to activate the menu items tab. Press the **MENU** key multiple times to tab right, and the **ESC** key multiple times to tab left, until the **TUNE** menu is highlighted and displaying the submenu items.
- 2) Use the **UP** and **DOWN** arrow keys to scroll through the sub menu items until **GAIN** is highlighted.
- 3) Press the **LEFT** and **RIGHT** arrow keys to scroll the value. When the correct **Gain** is being displayed, **proceed to step 8**.

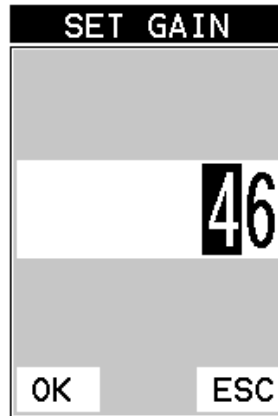

- 4) **Alternatively**, press the **ENTER** key to display the **Digits Edit Box**.
- 5) Press the **UP** and **DOWN** arrow keys to scroll the highlighted value.
- 6) Press the **LEFT** and **RIGHT** arrow keys to scroll the digit locations.
- 7) Repeat steps **5 & 6** until the **Gain** value is correctly displayed.
- 8) Press the **OK** key to set the **Gain** and return to the menu screen, or **ESC** to cancel entering the **Gain**.
- 9) Finally, press the **MEAS** key to return to the measurement screen and begin taking readings.

7.5 Threshold

The **Threshold** is the level (sensitivity) of the signal amplitude required to trigger the thickness reading. This level can be used in conjunction with the gain. Example: suppose the user can visually see a potential flaw on the display, but the **MVX** is not detecting on the flaw because the **Gain** is too low, or the **Threshold** too high. The **Threshold** level can be decreased (lower sensitivity) in order to detect signals with lower amplitudes. This will allow the amplitude from the reflection of the flaw to reach and exceed the **Threshold** level, and enable the **MVX** to detect on the flaw or defect. This can also be accomplished by increasing the **Gain**, allowing the signal to exceed the current **Threshold** level. Lowering the **Threshold** (increases sensitivity), and raising the **Threshold** decreases the sensitivity respectively.

The **MVX** is equipped with 2 independent gates, each with an adjustable threshold level. A single gate is used in pulse-echo mode, while both gates are used in echo-echo mode.

The procedures to adjust the **Thresholds** are outlined below:

Adjusting the Thresholds using the Hot Menu

DELAY:	0.086	RANGE:	0.229
GAIN:	46	THRESH1:	4
GATE1:	0.040	WIDTH1:	OFF
HOLD2:	0.050	LOG:	CLOSED
DELAY:	0.086	RANGE:	0.229
GAIN:	46	THRESH2:	2
GATE1:	0.040	WIDTH2:	OFF
HOLD2:	0.050	LOG:	CLOSED

THRESHOLDS	
THRESHOLD1	4
THRESHOLD2	2

- 1) Press the **MEAS** key once to activate measure menu items. Press the **MEAS** key multiple times to move right and the **ESC** key multiple times to move left, until the **THRESH(1-2)** cell is highlighted.
- 2) If the correct **THRESHOLD** is displayed, press the **UP**, **DOWN**, **LEFT**, and **RIGHT** arrow keys to scroll the highlighted value.
- 3) **Alternatively**, if the correct **Threshold** is not being displayed, press the **ENTER** key to display the **List Box**.

- 4) Use the **UP** and **DOWN** arrow keys to scroll through the **List Box** items until the correct **THRESHOLD** is highlighted.
- 5) Press the **MEAS** key to return to the measure screen and **Hot Menu** items.
- 6) Press the **UP**, **DOWN**, **LEFT**, and **RIGHT** arrow keys to scroll the highlighted value.
- 7) Repeat steps **3-6** until all the **THRESH** values are correctly adjusted.

The user can also access and adjust the **Threshold** from the tabbed menus. However, this method is more tedious than making the adjustments using **the Hot Menus**. The procedure for using the tabbed menus is outlined below:

Adjusting the Thresholds using the Tabbed Menus

START	-0.19
WIDTH 1	OFF
THRESHOLD 1	2
GT1	GT2 SET DATA

- 1) Press the **MENU** key once to activate the menu items tab. Press the **MENU** key multiple times to tab right, and the **ESC** key multiple times to tab left, until the **GT1** menu is highlighted and displaying the submenu items.
- 2) Use the **UP** and **DOWN** arrow keys to scroll through the sub menu items until **THRESHOLD1** is highlighted.
- 3) Press the **LEFT** and **RIGHT** arrow keys to scroll the value. When the correct threshold is being displayed, **proceed to step 8**.

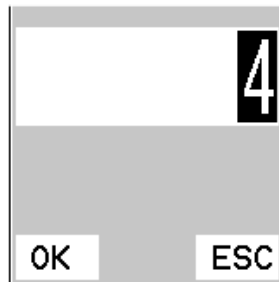

- 4) **Alternatively**, press the **ENTER** key to display the **Digits Edit Box**.
- 5) Press the **UP** and **DOWN** arrow keys to scroll the highlighted value.
- 6) Press the **LEFT** and **RIGHT** arrow keys to scroll the digit locations.
- 7) Repeat steps **5 & 6** until the **Threshold** number is correctly displayed.
- 8) Press the **OK** key to set the **Threshold** and return to the menu screen, or **ESC** to cancel entering the **Threshold**.
- 9) Repeat steps **1-8** to set any additional **Threshold** level.
- 10) Finally, press the **MEAS** key to return to the measurement screen and begin taking readings.

7.6 Understanding the features of the Gates

The sections that follow are procedures for using the features associated with the gates. There are two gates in the **MVX**. A single gate is active in pulse-echo, while both gates are active in echo-echo mode. The following diagram illustrates the features of the gates according to the measurement mode selected:

Modes	# Gates	Gate #	Start	HoldOff	Width	Threshold
PE	1	1	√		√	√
EE	2	1	√		√	√
		2		√	√	√

Gate Features vs Modes

In the diagram above, the gates have been associated with the measurement modes, along with the features available to each gate. For example, echo-echo mode (EE) has two gates available, while pulse-echo (P-E) only a single gate is used. Switching between modes will automatically toggle the gates on/off.

Note: *Switching between measurement modes will automatically toggle the gates on/off, and selecting the transducer/probe type will enable which modes are available for the probe selected. Gate 1 is always active in order to measure.*

Each gate has a given set of features to fine adjust the settings of the gate. Let's have a look at the feature set:

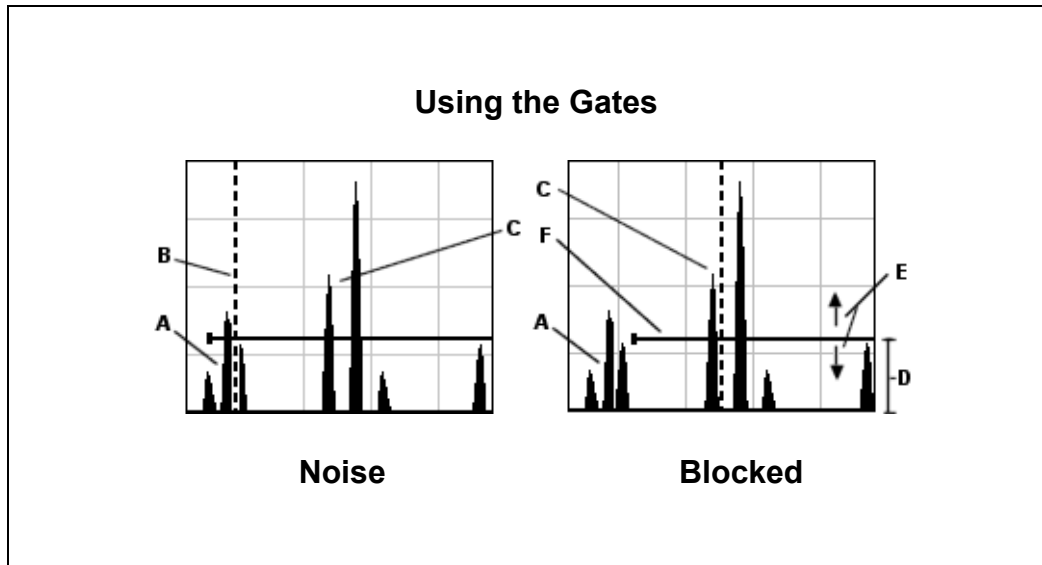

A = Surface noise or transducer ring.	D = Threshold level
B = Bad detection	E = Adjust sensitivity
C = Good detection	F = Gate

Start: This feature is only available to gate 1 and determines where the gate will start in terms of thickness. For example, if there's a great deal of noise from the initial pulse, or in the material, the gate can be set further out in time/thickness to avoid and block the noise from being detected.

Width: The width sets how wide the gate is from the start. If the start is set to 0.200", and the width set to 0.800", then the area of detection is from 0.200" to 1.00". If the width is set to 'off' the width is infinite.

Threshold: The threshold controls the level of sensitivity of the signal amplitude required to trigger a detection, or measurement. It is represented by the distance from the baseline, and displayed as the vertical position of a gate. The further the vertical position is from the baseline, the less sensitive the threshold is, and vice versa. When inspecting for small pits or defects, additional sensitivity will commonly be used. This feature is used in conjunction with gain, as increasing the threshold has a similar effect of decreasing the gain, and vice versa. By increasing the gain to an optimal level that doesn't introduce additional noise, lowering the threshold will increase the sensitivity and balance the overall signal to noise ratio.

Hold-Off: This feature is only available to gate 2. The hold-off is used only with gate two in echo-echo (through paint) mode. The hold-off is the amount of delay from the first detection before starting of gate two. If the first detection has cycle ring down noise, the hold-off can be adjusted beyond the cycle ring to avoid detection.

7.7 Adjusting the Gates

Now that the features of the gates are understood, this section focuses on how to make adjustments to those features. They can be adjusted from both the 'hot menus' as well as from the drop down tabbed menus. Both procedures are outlined as follows:

Note: The following is a combined procedure that works the same for all of the gate features for both gates. The symbol (X) will be defined to include (start, width, threshold or holdoff).

Hot Menus

DELAY: 0.275	RANGE: 0.373	DELAY: 0.275	RANGE: 0.373
AGC: 16	THRESH1: 7	AGC: 16	THRESH1: 7
START: -0.02	WIDTH1: OFF	START: -0.02	WIDTH1: OFF
HOLD2: 0.095	LOG: CLOSED	HOLD2: 0.095	LOG: CLOSED

Gate	Width																
<table border="1"> <tr> <td>DELAY: 0.275</td> <td>RANGE: 0.373</td> </tr> <tr> <td>AGC: 16</td> <td>THRESH1: 7</td> </tr> <tr> <td>START: -0.02</td> <td>WIDTH1: OFF</td> </tr> <tr> <td>HOLD2: 0.095</td> <td>LOG: CLOSED</td> </tr> </table>	DELAY: 0.275	RANGE: 0.373	AGC: 16	THRESH1: 7	START: -0.02	WIDTH1: OFF	HOLD2: 0.095	LOG: CLOSED	<table border="1"> <tr> <td>DELAY: 0.275</td> <td>RANGE: 0.373</td> </tr> <tr> <td>AGC: 16</td> <td>THRESH1: 7</td> </tr> <tr> <td>START: -0.02</td> <td>WIDTH1: OFF</td> </tr> <tr> <td>HOLD2: 0.095</td> <td>LOG: CLOSED</td> </tr> </table>	DELAY: 0.275	RANGE: 0.373	AGC: 16	THRESH1: 7	START: -0.02	WIDTH1: OFF	HOLD2: 0.095	LOG: CLOSED
DELAY: 0.275	RANGE: 0.373																
AGC: 16	THRESH1: 7																
START: -0.02	WIDTH1: OFF																
HOLD2: 0.095	LOG: CLOSED																
DELAY: 0.275	RANGE: 0.373																
AGC: 16	THRESH1: 7																
START: -0.02	WIDTH1: OFF																
HOLD2: 0.095	LOG: CLOSED																

HoldOff	Threshold
----------------	------------------

- 1) Press the **MEAS** key once to activate measure menu items. Press the **MEAS** key multiple times to move right and the **ESC** key multiple times to move left, until the (X) cell is highlighted.
- 2) Press the **UP**, **DOWN**, **LEFT**, and **RIGHT** arrow keys to scroll the highlighted value (course adjust).

- 3) Press the **ENTER** key at any time to enter the exact value required (fine adjust).
- 4) Press the **UP**, **DOWN**, **LEFT**, and **RIGHT** arrow keys to scroll the highlighted value.
- 5) Press the **OK** key to save the value, or **ESC** key to abort changes.

THRESHOLDS	
THRESHOLD 1	7
THRESHOLD 2	5

- 6) **Alternatively**, press the **ENTER** key to enter the digits (fine adjust) edit menu, or to display the **List Box**.

Note: *The list box option will only be available when adjusting the 'threshold' feature while in echo-echo measurement mode.*

- 7) Use the **UP** and **DOWN** arrow keys to scroll through the **List Box** items until the correct threshold is highlighted.
- 8) Press the **MEAS** key to return to the measure screen and **Hot Menu** items.
- 9) Press the **UP**, **DOWN**, **LEFT**, and **RIGHT** arrow keys to scroll the highlighted value.
- 10) Repeat steps **3-6** until all the **(X)** values are correctly adjusted.

The user can also access and adjust the **(X)** from the tabbed menus. However, this method is more tedious than making the adjustments using **the Hot Menu**. The procedure for using the tabbed menus is outlined below:

Adjusting the Features of the Gates using the Tabbed Menus

START	-0.36	WIDTH 2	OFF
WIDTH 1	OFF	HOLD2	0.095
THRESHOLD 1	2	THRESHOLD 2	5
GT1	GT2	SET	DATA
GT1	GT2	SET	DATA

- 1) Press the **MENU** key once to activate the menu items tab. Press the **MENU** key multiple times to tab right, and the **ESC** key multiple times to tab left, until the **(X)** menu is highlighted and displaying the submenu items.
- 2) Use the **UP** and **DOWN** arrow keys to scroll through the sub menu items until **(X)** is highlighted.
- 3) Press the **LEFT** and **RIGHT** arrow keys to scroll the value. When the correct **(X)** is being displayed, **proceed to step 8**.

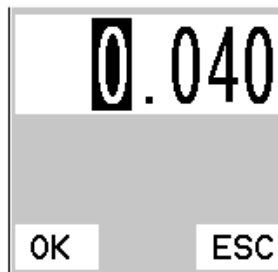

- 4) **Alternatively**, press the **ENTER** key to display the **Digits Edit Box**.
- 5) Press the **UP** and **DOWN** arrow keys to scroll the highlighted value.
- 6) Press the **LEFT** and **RIGHT** arrow keys to scroll the digit locations.
- 7) Repeat steps **5 & 6** until the **(X)** number is correctly displayed.
- 8) Press the **OK** key to set the **(X)** and return to the menu screen, or **ESC** to cancel entering the **(X)**.
- 9) Repeat steps **1-8** to set any additional **(X)** level.

10) Finally, press the **MEAS** key to return to the measurement screen and begin taking readings.

CHAPTER EIGHT

THRU PAINT MEASUREMENT TECHNIQUE

8.1 Introduction to Thru Paint Measurement

The principle behind thru paint measurement is by measuring the time between two back wall echoes returning from the test material. Since both of these back wall echoes travel the same path through the paint or coating, the thickness of the coating is subtracted out of the measurement, measuring only the base material. This avoids the time to remove existing coating from the test material during the inspection process.

Thru paint mode cannot be used for flaw or pit detection. Therefore, inspectors may need to use echo-echo thru paint mode in conjunction with the standard pulse-echo flaw detection mode for some applications. The combination of using both modes is ideal for achieving the nominal base material thickness, as well as for finding defects or pitting in materials.

8.2 Using Thru Paint Mode

The first thing to note in this section, is that by selecting the transducer type from the list of probes stored in the **MVX**, a basic echo-echo thru paint configuration is recalled from memory. Each of the 'high damped' transducers in the list contain pre-configured echo-echo settings. However, fine adjustments may be necessary in order to be suitable for your specific applications. These configurations are general setups only. Once the transducer type has been selected, and the appropriate calibration procedure completed, the **MVX** can be toggled between **pulse-echo** (flaw & pits), and **echo-echo** (thru-paint) modes by simply pressing the **MULTI MODE** key located on the keypad. The standard transducer that will be used for common steel applications is a 1/4" 5MHz high damped transducer (**1/4IN – 5.0MHZ HD**). However, any of the transducers with the **HD** label have been optimized for echo-echo thru paint applications.

Note: *When a transducer is selected for use, all of the measurement modes available for use with this transducer can easily be determined by pressing the multi-mode button on the keypad. The **MVX** has been programmed to identify the modes available to a specific transducer.*

When configuring the **MVX** for specific thru paint applications, all of the scope parameters will potentially be needed. The delay, range, gain (AGC), thresholds, gates, and hold-offs will be subject to change. For this reason, they have all been

added to **Hot Menu** fields located directly beneath the A-Scan display for quick and easy access.

Note: *Once the values of the fields have been changed or modified, these changes must be saved to a setup location prior to powering the **MVX** off. **Failure to do so will result in losing your changes.** Refer to page 111 for additional information on setups.*

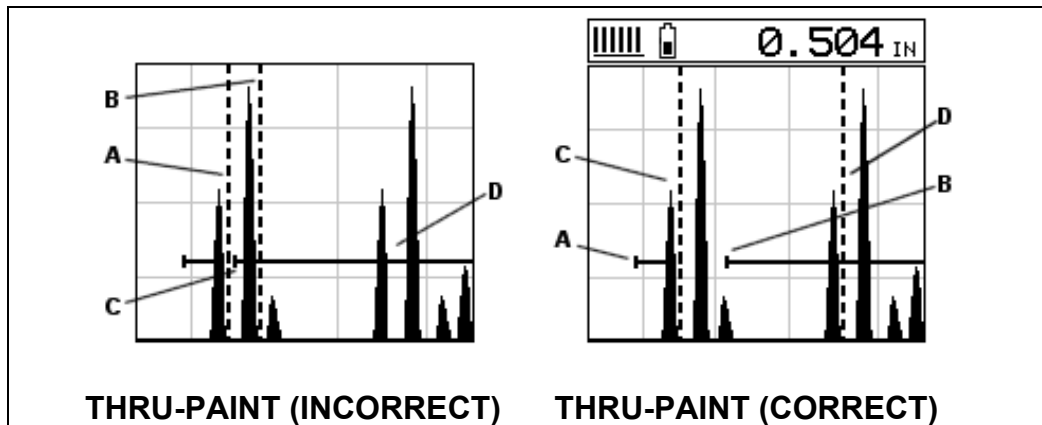

Refer to the 'incorrect' diagram above. Point **(A)** represents the detection on the first back wall echo, indicated by the broken dotted vertical line. The actual second back wall reflection should be detecting at point **(D)**. However, the hold-off **(C)** is setup incorrectly and the **MVX** is detecting the ring down noise of the transducer on the first reflection, rather than the actual second back wall reflection shown at **(D)**.

Before we look at the diagram with the correct configuration, let's consider all of our options on how to fix the problem. Our **delay** and **Range** (zoom) will simply change the view options of the screen and not needed in this example. Will a **gain (AGC)** or **threshold** adjustment fix the problem? Unfortunately, not. Why? Notice the amplitude of the cycle just to the left of **(B)**. If we tried to increase the threshold level above the height of the cycle, we would lose our detection for both echoes resulting in no reading at all. If we decrease our **gain (AGC)**, reducing the signal amplitudes, we would also lose our detection of both back wall echoes.

Notice that the amplitude of the cycle just to the left of **(C)**. The amplitude of the cycle, at **(C)**, is less than the amplitude of the cycle at **(B)**, in terms of overall height. If we decreased our **gain (AGC)**, we would lose the first cycle **(C)** long before losing the second cycle **(B)**. Therefore, adjusting the **gain (AGC)** or **threshold** levels will not help us in this example. Our final option is adjusting the **GATE2** hold-off, shown at point **(C)** in the incorrect diagram, to point **(B)** in the correct diagram. If we adjust the **GATE2** hold-off further to the right of the first reflection, the ring down noise from the first back wall echo no longer interferes with the true detection **(D)**, shown in the correct diagram.

The adjustment considerations in the example above will typically be used for all thru paint applications respectively. In some applications the hold-off may be sufficient, while a **gain(AGC)** or **thresholds** adjustment will solve the problem. A similar process of elimination should be considered for all thru paint applications.

CHAPTER NINE ADDITIONAL FEATURES OF THE MVX

9.1 Graphics Options (look & feel)

We've added a couple of graphic interface features to the **MVX**, accommodate customer requests we've received in the past. These features only serve as cosmetic items, and do not change the functionality of the **MVX** in any way.

RECT Wave:

The rectified wave feature, is only functional when using **RECT** wave view, and provides the user the following display options:

Outline – Draws the unfilled outline of the waveform.

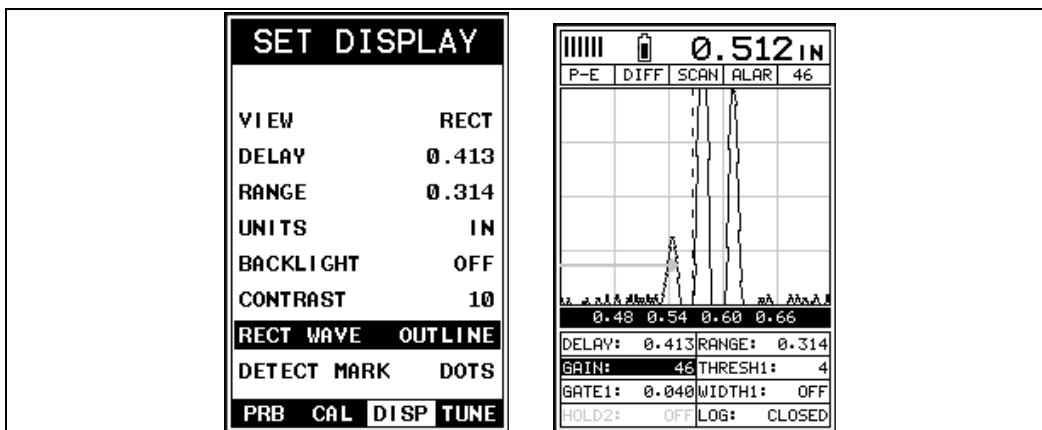

Filled – Draws a filled version of the waveform.

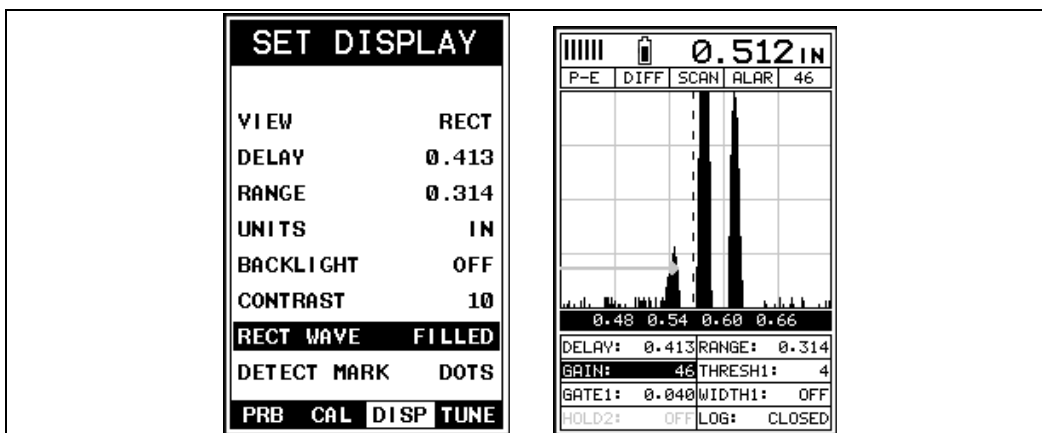

Detect Mark:

The detect mark is another look and feel option for displaying the detection indicator.

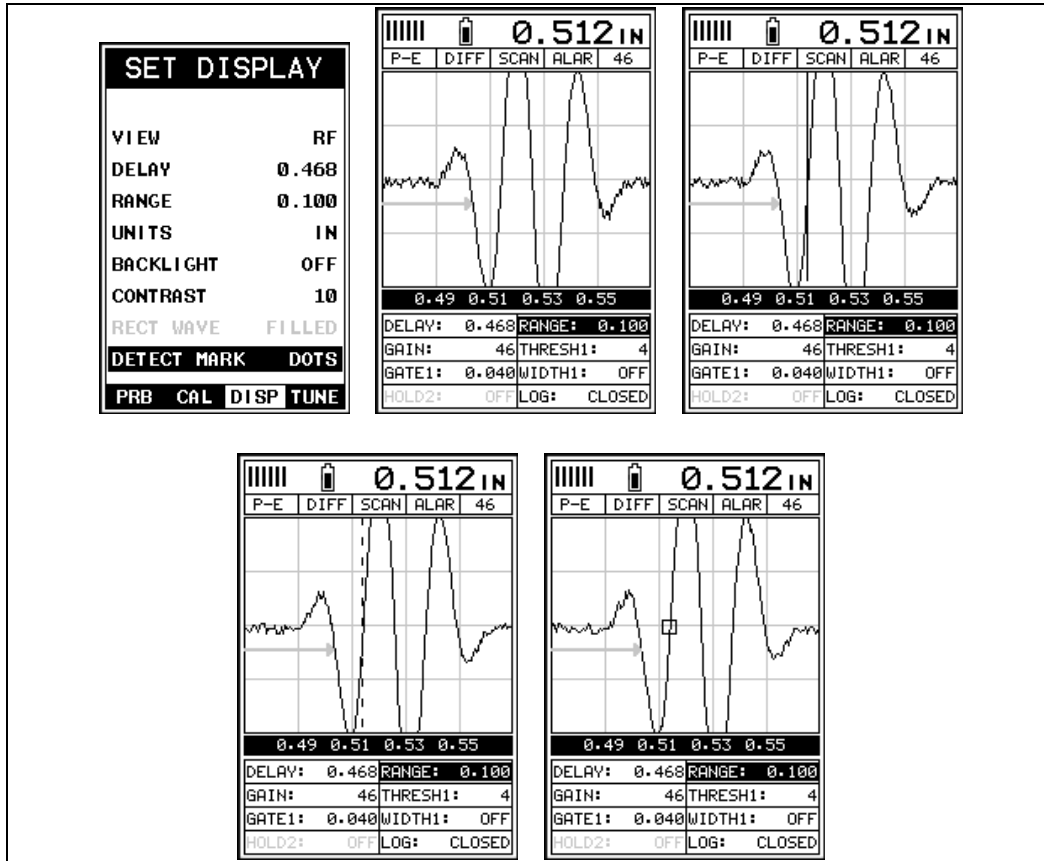

9.2 Polarity

The *MXV* is equipped with an option to select the polarity, or phase +/-, for the purpose of detection. The phase can be a very valuable feature to have when the signal returning from the test material is marginal, a low frequency transducer is being used, or the user has a very weak positive or negative cycle while trying to measure very thick materials. There is a possibility that signal will become so weak that it falls below the threshold and 'peak jumps' to the next cycle. This peak jump represents a shift of the detection further out in time, resulting in an incorrect measurement. The material being measured will appear thicker than it actually is. Refer to the diagram below:

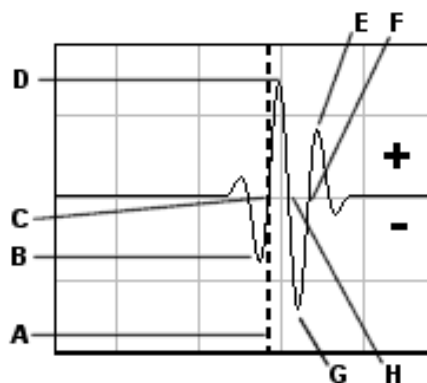

Notice the +/- positions in the diagram. The positive phase is everything above the horizontal center line, and the negative everything below the center line. The **MX** uses a **zero crossing (flank) method for detection**. Therefore, the detect line (**A**) is represented by the broken vertical dotted line, and is currently detecting on the negative portion of the waveform (**B**) at the zero crossing (**C**). The signal amplitude (**B**) is shown as the negative vertical height at (**B**) in the diagram. Refer to the height of the second negative peak at (**G**). It's clear that the amplitude of (**G**) is much greater than that of (**B**). Therefore, if the user was measuring thick attenuative material, and the amplitude of (**B**) decreased substantially, the **MX** would lose the first cycle (**B**) and peak jump to the second cycle (**F**). The detect (**A**), would move to (**F**), resulting in incorrect measurements.

If the user were to select the positive phase in the diagram above, the detect would measure at (**H**). (**A**) would move to (**H**). Notice the height of (**D**) with respect to the height of (**E**) in the diagram. If the user was measuring thick attenuative material using this phase, the signal (**E**) will certainly be lost long before (**D**). Therefore, the positive phase is a much better choice in the diagram above.

Toggle Polarity (+/-)

TUNE SIGNAL	
MEASURE MODE	P-E
POLARITY	NEGATIVE
PULSE	THIN
PULSER VOLT	150
ATTN	0 DB
GAIN	46
AGC	0
PRB	CAL DISP TUNE

Note: Before toggling the **Polarity**, the **MVX** should be set to the **RF** display view option. The **RF** view will give the user the best opportunity to correctly view the positive and negative cycles of the waveform. Please refer to page 43 for information on selecting the **Display Views**.

- 1) Press the **MENU** key once to activate the menu items tab. Press the **MENU** key multiple times to tab right, and the **ESC** key multiple times to tab left, until the **TUNE** menu is highlighted and displaying the submenu items.
- 2) Use the **UP** and **DOWN** arrow keys to scroll through the sub menu items until **POLARITY** is highlighted.
- 3) Use the **LEFT** and **RIGHT** arrow keys to toggle the **POLARITY** negative or positive.
- 4) Press the **MEAS** key to return to the measurement screen and begin taking readings.

Important: Be sure to do a Probe Zero after changing the polarity!

9.3 Pulse

The **MVX** has an adjustable pulse width option. Pulse width, refers to the duration of time the pulser is left on. This time results in increased energy sent into the test material. There are three width options (**SPIKE**, **THIN**, and **WIDE**). The **SPIKE** setting may be desirable for high resolution and general applications to decrease the overall noise. This can be considered the normal or standard setting. When additional energy is needed, more penetration, the **THIN** and **WIDE** options may be necessary. The procedure to change the pulse width is outlined below:

Selecting the Pulse Width

TUNE SIGNAL	
MEASURE MODE	E-E
POLARITY	NEGATIVE
PULSE	THIN
GAIN	52.0
AGC	16
PRB	CAL DISP TUNE

- 1) Press the **MENU** key once to activate the menu items tab. Press the **MENU** key multiple times to tab right and the **ESC** key multiple times to tab left until the **TUNE** menu is highlighted and displaying the submenu items.
- 2) Use the **UP** and **DOWN** arrow keys to scroll through the sub menu items until **PULSE** is highlighted.
- 3) Use the **LEFT** and **RIGHT** arrow keys to scroll the **Pulse** options.
- 4) Once the **Pulse** is displayed, press the **MEAS** key to return to the measurement screen.

9.4 Auto Find

The **MVX** is equipped with a very handy feature for locating the detection point of a back wall echo that is not currently in the viewable region of the display. Suppose the **MVX** is currently setup with a delay of 0.0" and a width of 1.0", and the user is measuring material thickness of 2.5". The **MVX** will make the correct measurement and display it digitally. However, the waveform will not show up at all in both A-Scan views, and incorrectly in the B-Scan view without adjusting the range of the **Delay** and **Width** accordingly.

The **AUTO FIND** feature is a convenient way to let the **MVX** find the detection point and bring the waveform signal into view automatically. The user can then make small adjustments to the range once the signal is displayed on the screen. The procedure to use the **AUTO FIND** feature is outlined below:

Using Auto Find

UTILITIES	
AUTO FIND	
SCAN MODE	OFF
ALARM	OFF
ALARM HIGH	1.000
ALARM LOW	0.000
DIFFERENTIAL	OFF
KEY CLICK	QUIET
SET DATE	MMDDYY
SHOW DATE	OFF
DATA UTIL XFER	

- 1) Press the **MENU** key once to activate the menu items tab. Press the **MENU** key multiple times to tab right, and the **ESC** key multiple times to tab left, until the **UTIL** menu is highlighted and displaying the submenu items.
- 2) Use the **UP** and **DOWN** arrow keys to scroll through the sub menu items until **AUTO FIND** is highlighted.
- 3) Place the transducer on the test material and obtain a reading.
- 4) Press the **ENTER** key to automatically adjust the display settings and bring the waveform into view.
- 5) Once the signal is displayed, press the **MEAS** key to return to measurement mode.

9.5 High Speed Scan

The High Speed Scan feature of the **MVX** increases the overall repetition rate to a maximum of 250Hz with a high speed screen refresh rate of 25 times a second. This feature enables a user to make scanned passes over an arbitrary length of the test material, while still maintaining a reasonable representation of thickness over the scanned area or region. This feature can be used in conjunction with High and Low alarm limits features to dynamically keep track of both values. The feature is typically used to provide a better representation of the area scanned, by taking more readings at a faster rate repetition rate.

The procedure to use the **SCAN MODE** feature is outlined below:

Using the Scan Mode

UTILITIES	
AUTO FIND	
SCAN MODE	ON
ALARM	ON
ALARM HIGH	1.000
ALARM LOW	0.000
DIFFERENTIAL	OFF
KEY CLICK	QUIET
SET DATE	MMDDYY
SHOW DATE	OFF
DATA UTIL XFER	

- 1) Press the **MENU** key once to activate the menu items tab. Press the **MENU** key multiple times to tab right and the **ESC** key multiple times to tab left until the **UTIL** menu is highlighted and displaying the submenu items.
- 2) Use the **UP** and **DOWN** arrow keys to scroll through the sub menu items until **SCAN MODE** is highlighted.
- 3) Use the **LEFT** and **RIGHT** arrow keys to toggle the **SCAN MODE** on/off.
- 4) Press the **MEAS** key to return to the measurement screen.

9.6 Alarm Mode

The **Alarm Mode** feature of the **MVX** provides the user with a method of setting tolerances, or limits, for a particular application requirement. This feature may be used for a variety of applications to verify the material is within the manufacturer specifications. There are two limits, or alarm values, that can be setup in the **MVX** – **ALARM LOW** and **ALARM HIGH** limits. However, the user may choose to activate and utilize only one of the limit values, depending on their specific application requirements. The procedures to use the **ALARM MODE** feature are outlined below:

Toggle Alarm (on/off)

UTILITIES	
AUTO FIND	
SCAN MODE	ON
ALARM	ON
ALARM HIGH	0.225
ALARM LOW	0.190
DIFFERENTIAL	OFF
KEY CLICK	QUIET
SET DATE	MMDDYY
SHOW DATE	OFF
DATA UTIL XFER	

- 1) Press the **MENU** key once to activate the menu items tab. Press the **MENU** key multiple times to tab right, and the **ESC** key multiple times to tab left, until the **UTIL** menu is highlighted and displaying the submenu items.
- 2) Use the **UP** and **DOWN** arrow keys to scroll through the sub menu items until **ALARM** is highlighted.
- 3) Use the **LEFT** and **RIGHT** arrow keys to toggle the **ALARM** on/off/audible.
- 4) Continue on to the next section “**Setting the Alarm Low Limit**”.

Setting the Alarm Low Limit

UTILITIES	
AUTO FIND	
SCAN MODE	ON
ALARM	ON
ALARM HIGH	0.225
ALARM LOW	0.190
DIFFERENTIAL	OFF
KEY CLICK	QUIET
SET DATE	MMDDYY
SHOW DATE	OFF
DATA UTIL XFER	

UTILITIES	
AUTO FIND	
SCAN MODE	ON
ALARM	ON
ALARM HIGH	0.225
ALARM LOW	0.750
DIFFERENTIAL	OFF
KEY CLICK	QUIET
SET DATE	MMDDYY
SHOW DATE	OFF
DATA UTIL XFER	

- 1) Assuming the **ALARM** is **ON**, use the **UP** and **DOWN** arrow keys to scroll through the sub menu items until **ALARM LOW** is highlighted.
- 2) Press the **LEFT** and **RIGHT** arrow keys to scroll the value. When the correct alarm value is being displayed, **proceed to step 7**.

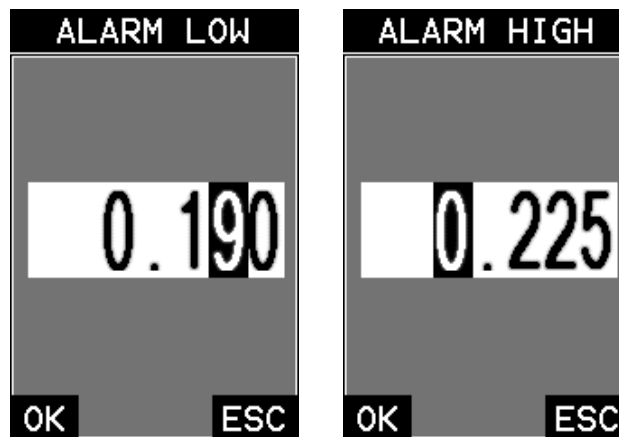

- 3) **Alternatively**, press the **ENTER** key to display the **Digits Edit Box**.
- 4) Press the **UP** and **DOWN** arrow keys to scroll the highlighted value.
- 5) Press the **LEFT** and **RIGHT** arrow keys to scroll the digit locations.
- 6) Repeat steps **4 & 5** until the **ALARM LOW** value is correctly displayed.
- 7) If only one limit will be used, press the **MEAS** key to return to the measurement screen and begin taking readings. Otherwise, continue on to set the **ALARM HIGH** limit using the same procedures.

9.7 Differential Mode

The **Differential Mode** of the **MVX** provides the user with the ability to set a nominal value, according to what the expected thickness should be, and measure the +/- difference from the nominal value entered. This feature is typically used in QA incoming inspections on pipes, plate stock, coils, etc. The steps below outline how to enable and enter the nominal value to use this feature:

Toggle Differential (on/off)

UTILITIES	
AUTO FIND	
SCAN MODE	OFF
ALARM	ON
ALARM HIGH	0.225
ALARM LOW	0.190
DIFFERENTIAL	0.600
KEY CLICK	QUIET
SET DATE	MMDDYY
SHOW DATE	OFF
DATA UTIL XFER	

- 1) Press the **MENU** key once to activate the menu items tab. Press the **MENU** key multiple times to tab right, and the **ESC** key multiple times to tab left, until the **UTIL** menu is highlighted and displaying the submenu items.
- 2) Use the **UP** and **DOWN** arrow keys to scroll through the sub menu items until **DIFFERENTIAL** is highlighted.
- 3) Use the **LEFT** and **RIGHT** arrow keys to toggle the **DIFFERENTIAL** on. A value will appear to the right of **DIFFERENTIAL**.
- 4) Continue on to the next section "**Setting the Differential Value**".

Setting the Differential Value

ENTER NOMINAL VALUE	
0.000	
OK	ESC

- 1) Assuming **DIFFERENTIAL** has been enabled and a value is being displayed to the right of the **DIFFERENTIAL** label, press the **ENTER** key to display the **Digits Edit Box**.
- 2) Press the **UP** and **DOWN** arrow keys to scroll the highlighted value.
- 3) Press the **LEFT** and **RIGHT** arrow keys to scroll the digit locations.
- 4) Repeat steps **2 & 3** until the **DIFFERENTIAL** value is correctly displayed.
- 5) Press the **OK** key to set the **DIFFERENTIAL** value and return to the menu screen.
- 6) Finally, press the **MEAS** key to return to the measurement screen and begin taking readings.

9.8 Key Click

When a key is pressed on the **MVX** keypad, the user can control whether or not an audible beep is sounded and at what volume level, if any. The procedure for this feature/preference is outlined below:

Setting the Key Click

UTILITIES	
AUTO FIND	
SCAN MODE	OFF
ALARM	ON
ALARM HIGH	1.000
ALARM LOW	0.000
DIFFERENTIAL	OFF
GAUGE	THICKNESS
KEY CLICK	QUIET
SET DATE	MMDDYY
SHOW DATE	BOTH
DATA	UTIL XFER

- 1) Press the **MENU** key once to activate the menu items tab. Press the **MENU** key multiple times to tab right and the **ESC** key multiple times to tab left until the **UTIL** menu is highlighted and displaying the submenu items.

- 2) Use the **UP** and **DOWN** arrow keys to scroll through the sub menu items until **KEY CLICK** is highlighted.
- 3) Use the **LEFT** and **RIGHT** arrow keys to toggle the **KEY CLICK** loud/quiet/off.
- 4) Press the **MEAS** key to return to the measurement screen.

9.9 Set Date & Time

The **MXV** is equipped with an internal clock to time and date stamp the log, setup and screen capture files for reporting/documentation purposes. The procedures for setting the time and date are outlined below:

Setting Date & Time

UTILITIES	
AUTO FIND	
SCAN MODE	OFF
ALARM	ON
ALARM HIGH	1.000
ALARM LOW	0.000
DIFFERENTIAL	OFF
GAUGE	THICKNESS
KEY CLICK	QUIET
SET DATE	MMDDYY
SHOW DATE	BOTH
DATA	UTIL XFER

- 1) Press the **MENU** key once to activate the menu items tab. Press the **MENU** key multiple times to tab right and the **ESC** key multiple times to tab left until the **UTIL** menu is highlighted and displaying the submenu items.
- 2) Use the **UP** and **DOWN** arrow keys to scroll through the sub menu items until **SET DATE** is highlighted.

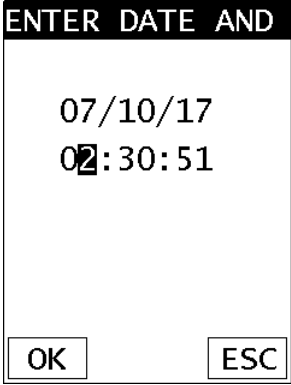

3) Press the **ENTER** key to display the **Digits Edit Box**.

4) Press the **UP, DOWN, LEFT, & RIGHT** arrow keys to scroll the field locations.

5) Press the **LEFT** and **RIGHT** arrow keys multiple times to scroll the value.

6) Repeat steps **4 & 5** until the **Time & Date** is correctly displayed.

7) Press the **OK** key to set the **Time & Date** and return to the menu screen, or **ESC** to cancel entering the **Time & Date**.

8) Finally, press the **MEAS** key to return to the measurement screen and begin taking readings.

9.10 Show Date & Time

The **MVX** can be configured to show the date & time in the active A-Scan window as needed or preferred (off/date/time/both). The procedure for activating and displaying the above options are outlined below:

Live Time & Date

UTILITIES	
AUTO FIND	
SCAN MODE	OFF
ALARM	OFF
ALARM HIGH	1.000
ALARM LOW	0.000
DIFFERENTIAL	OFF
GAUGE	THICKNESS
KEY CLICK	QUIET
SET DATE	MMDYY
SHOW DATE	BOTH
DATA	UTIL XFER

- 1) Press the **MENU** key once to activate the menu items tab. Press the **MENU** key multiple times to tab right and the **ESC** key multiple times to tab left until the **UTIL** menu is highlighted and displaying the submenu items.
- 2) Use the **UP** and **DOWN** arrow keys to scroll through the sub menu items until **SHOW DATE** is highlighted.
- 3) Press the **LEFT** and **RIGHT** arrow keys multiple times to scroll the options (Date, Time, Both, Off).
- 4) Finally, press the **MEAS** key to return to the measurement screen and begin taking readings.

9.11 Freeze & Capture

The **MVX** freeze feature enables a user to immediately freeze what's currently being displayed on the screen for further review or analysis. The freeze feature used in conjunction with the capture feature enables a user to save the entire screen shot directly to a **.tif** (tagged image) file format that can be opened using any graphics viewer. With the storage capacity of the **MVX** the user can store as many screens shots as needed. It should also be mentioned that this feature is immediately activated on boot up. Therefore all the menus items, list boxes and edit screens can also be captured for presentation or training purposes. The procedure to freeze and capture the display is outlined below:

Capturing Screen Shots

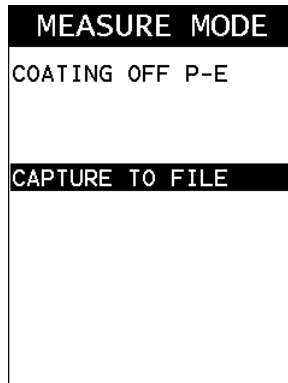

- 1) To capture a file, press the **MULT MODE** key to freeze the screen and enter the measure mode menu.
- 2) Press the **UP** and **DOWN** arrow keys multiple times until **CAPTURE TO FILE** is highlighted.

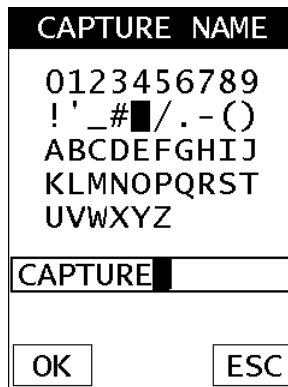

- 3) Press the **ENTER** key to display the alpha numeric edit box to name and save the screen shot.
- 4) Press the **MEAS** key to return to the measurement screen.

9.12 Capture Viewer

The capture viewer enables a user to view any of the saved screen captures on the SD card, using the **MVX**. This is handy if a PC isn't available, but the user has a need to review the screen shots captured.

The procedure to capture the last screen displayed is outlined below:

Using the Viewer

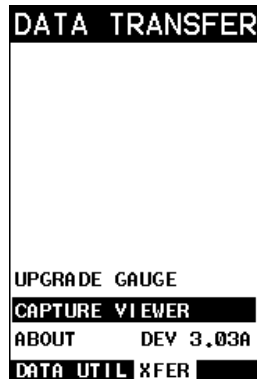

- 1) Press the **MENU** key once to activate the menu items tab. Press the **MENU** key multiple times to tab right and the **ESC** key multiple times to tab left until the **XFER** menu is highlighted and displaying the submenu items.
- 2) Press the **UP** and **DOWN** arrow keys until **CAPTURE VIEWER** is highlighted.

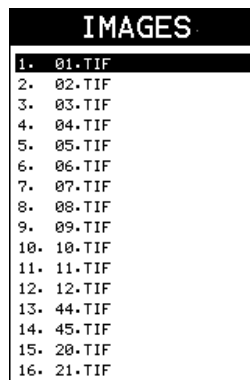

- 3) Press the **ENTER** key to display the list of images saved on the SD card.
- 4) Use the **UP** and **DOWN** arrow keys to scroll through the list until the desired image name is highlighted.
- 5) Press the **ENTER** key to display the image.

6) Press the **MEAS** key to return to the measurement screen.

CHAPTER TEN DATA STORAGE – SETUP, EDIT, & VIEW FILES

10.1 Introduction to the Grid file format

The **GRID** file format is very similar to a spreadsheet format found in popular software programs like Excel. A **GRID** is simply a table of readings. A specific location in a grid is specified by giving a row and column coordinate. The rows are numbered from 1 to 999 and the columns are labeled from A to ZZ (999 Rows & 52 Columns).

The following character set below are the characters that can be used when when creating a name or note as follows:

Numeric characters: 0 – 9 **Alpha Characters:** A – Z

Special Characters: ! ' _ # space / . - ()

Note: *The name and note fields are 20 characters in length using any combination of the above character set.*

Multiple grids can be created and stored until the **MVX**'s memory is full. If the user attempts to store a new file in the **MVX** and the size of the file exceeds the capacity of memory, the **MVX** will respond with an error message indicating that the memory is unable to store the new file.

The **MVX** has a 4gb SD memory card for virtually unlimited storage capacity. Along with every measurement stored, is a corresponding screenshot of the **DIGITS**, **RF**, **RECT**, or **B-SCAN** views, as well as all the **MVX** settings for every individual measurement. The screenshot stored with the reading will depend on what view the **MVX** was in at the time it was saved. For example, if the view was in **RECT**, then a **RECT** waveform will be saved with the reading.

The sections that follow are a guide for creating a grid:

NAME: EX#1			
	A	B	C
1			
2			
3			
4			

NAME: EX#2			
	D	E	F
6			
7			
8			
9			

Grid File Format

10.2 Creating a new Grid

Grid Name

STORE DATA

NEW **GRID LOG**

EDIT

OPEN

CLOSE

DELETE ONE ENTRY

DELETE ALL DATA

SET DATA UTIL XFER

- 1) Press the **MENU** key once to activate the menu items tab. Press the **MENU** key multiple times to tab right, and the **ESC** key multiple times to tab left, until the **DATA** menu is highlighted and displaying the submenu items.
- 2) Use the **UP** and **DOWN** arrow keys to scroll through the sub menu items until **NEW** is highlighted.
- 3) Press the **ENTER** key to display the new grid setup box.
- 4) Use the **UP** and **DOWN** arrow keys to scroll through the new grid options until **NAME** is highlighted.

LOG NAME
0123456789
! ' _ # / . - ()
ABCDEFGHIJ
KLMNOPQRST
UVWXYZ
BOILER 34

OK

ESC

- 5) Press the **ENTER** key to activate the **Alpha Edit Box**.
- 6) Use the **UP, DOWN, LEFT, & RIGHT** arrow keys to highlight the appropriate alpha characters.
- 7) Press the **ENTER** key to select a character and advance to the next field of the grid name.
- 8) Use the **CLR** key to backspace if necessary.
- 9) Repeat steps **6 - 9** until the grid name is complete.
- 10) Press the **OK** key to save the grid and return to the grid setup list, or **ESC** to cancel creating a **NAME**.

Creating a Note

NEW GRID LOG	
NAME:	BOILER 34
NOTE:	INSP#99
TOP LEFT:	A001
LOWER RIGHT	A001
INCR. DIR:	NONE
SAVE GRAPHICS	NO
CREATE GRID?	
GRID SIZE:	1

- 1) Use the **UP** and **DOWN** arrow keys to scroll through the setup options until **NOTE** is highlighted.
- 2) Press the **ENTER** key to activate the **Alpha Edit Box**.

LOG NOTE
0123456789
! ' _ # / . - ()
ABCDEFGHIJ
KLMNOPQRST
UVWXYZ
INSP#99

OK

ESC

- 3) Use the **UP**, **DOWN**, **LEFT**, & **RIGHT** arrow keys to highlight the appropriate alpha characters.
- 4) Press the **ENTER** key to select a character and advance to the next field.
- 5) Use the **CLR** key to backspace if necessary.
- 6) Repeat steps **3** through **5** until the **Note** is complete.
- 7) Press the **OK** key to save the **Grid** and return to the setup list, or **ESC** to cancel entering a **Note**.

Setting the Coordinates or Start & Stop ID's

A grid is defined by using coordinates to define the **Top Left** and the **Bottom Right** corners of the grid. Alpha coordinates are horizontal across the top, and numeric coordinates are vertical down the side. Therefore, to define the top left corner of the grid, there will be an (X,Y) coordinate. Where X is an alpha column location across the top and Y is a numeric row location down the side. Use the same logic when choosing the lower right corner. An individual grid can be up to 999 rows and 52 columns.

Grid Coordinates – Top Left

NEW GRID LOG	
NAME:	BOILER 34
NOTE:	INSP#99
TOP LEFT:	A001
LOWER RIGHT	A001
INCR. DIR:	NONE
SAVE GRAPHICS	NO
CREATE GRID?	
GRID SIZE:	1

- 1) Use the **UP** and **DOWN** arrow keys to scroll through the setup list until **TOP LEFT** is highlighted.
- 2) Press the **ENTER** key to activate the **Coordinate Edit Box**.

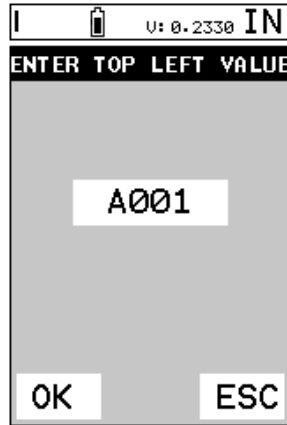

- 3) Use the **LEFT** and **RIGHT** arrow keys to scroll the **Columns**, and the **UP** and **DOWN** arrow keys to scroll the **Rows**.
- 4) Press the **OK** key to select the coordinate and return to the setup list, or **ESC** to cancel setting the coordinate.

Grid Coordinates – Lower Right

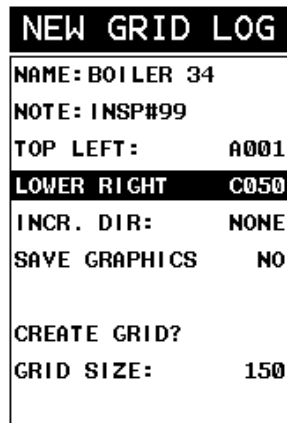

- 1) Use the **UP** and **DOWN** arrow keys to scroll through the setup list until **LOWER RIGHT** is highlighted.

- 2) Press the **ENTER** key to activate the **Coordinate Edit Box**.



- 3) Use the **LEFT, & RIGHT** arrow keys to scroll the **Columns**, and the **UP** and **DOWN** arrow keys to scroll the **Rows**.
- 4) Press the **OK** key to select the coordinate and return to the setup list, or **ESC** to cancel the selection and return to the setup list.

Note: *If there is not enough memory available to create the grid or sequential log, an error message box "**NOT ENOUGH MEMORY**" will be displayed.*

Auto Increment Direction

The **Auto Increment** feature gives the user the ability to specify which direction to advance the cursor after storing a reading.

NEW GRID LOG	
NAME:	BOILER 34
NOTE:	INSP#99
TOP LEFT:	A001
LOWER RIGHT	C050
INCR. DIR:	EAST
SAVE GRAPHICS	NO
CREATE GRID?	
GRID SIZE:	150

- 5) Use the **UP** and **DOWN** arrow keys to scroll through the setup list until **INCR. DIR** is highlighted.
- 6) Use the **LEFT** and **RIGHT** arrow keys to toggle the **Increment** direction **NONE, NORTH, EAST, SOUTH, or WEST**.
- 7) Continue on to the next section "**Saving a Grid or Seq File**".

Saving a Grid

Once all the parameters are set, the user has the option of saving or canceling the new grid setup.

NEW GRID LOG	
NAME:	BOILER 34
NOTE:	INSP#99
TOP LEFT:	A001
LOWER RIGHT	C050
INCR. DIR:	EAST
SAVE GRAPHICS	NO
CREATE GRID?	
GRID SIZE:	150

- 1) Use the **UP** and **DOWN** arrow keys to scroll through the setup list until **CREATE GRID** is highlighted.
- 2) Press the **ENTER** key to save the grid display the confirmation screen.

CREATE GRID?	
CREATE A NEW DATA GRID	
?	
OK	ESC

- 3) Press the **OK** key to save the **Grid**, or the **ESC** key to cancel the setup and return to the **DATA** menu.
- 4) Press the **MEAS** key to return to the measurement screen and begin storing readings.

10.3 Storing a reading

Now that a grid or sequential log has been created, it's time to make some measurements and store the readings. The following procedures outline this process:

Storing Data

Note: *Once the grid has been created it will automatically be displayed following the create confirmation screen. It is located at the bottom of the measurement screen, and can be left open for the duration of the inspection process. This section assumes the grid or sequential log was just created. Refer to the section on "opening a grid or seq log" if the file was created at another time.*

Key Feature: When the **MVX** is displaying a grid in the measurement screen, pressing the **OK** key will initiate an advance to row number option. Use the **Left, Right, UP,** and **DOWN** arrow keys to enter the row number. Once the row number is correctly displayed, press the **OK** key to advance directly to that row in the grid.

Key Feature: When the **MVX** is displaying a grid in the measurement screen, pressing the **ESC** key multiple times will toggle through the display options: **Digits, RF, RECT,** and **B-SCAN** views.

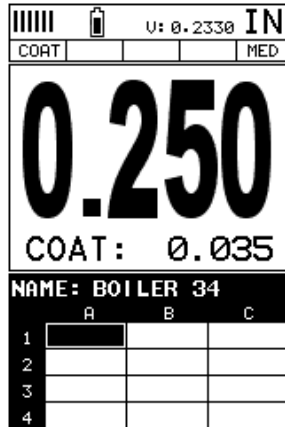

- 1) Press the **UP**, **DOWN**, **LEFT**, and **RIGHT** arrow keys to scroll the target cell cursor to the desired storage location.
- 2) Press the **ENTER** key to save the current reading in the highlighted cell location.
- 3) Press the **MEAS** key to hide the **GRID** and display the **Hot Menu**.
- 4) To display the **GRID**, press the **MEAS** or **ESC** keys multiple times until **LOG** is highlighted.
- 5) Press the **ENTER** to display the **GRID**.

Note: *Once the file is open, it will remain open until it's closed or another file is opened by the user. If the gauge is powered off, the **MVX** will automatically open the file when powered on.*

10.4 Viewing stored readings

It is sometimes necessary to go back and view the stored readings and B-Scans using the **MVX** without a PC. The following procedures outline this process:

Viewing Stored Readings & A/B Scans

MEM	U: 0.2330 IN		
COAT		MED	
0.300			
COAT: 0.035			
NAME: BOILER 34			
	A	B	C
1	0.250	0.500	0.750
2	0.200	0.300	
3			
4			

DELAY: 0.000	RANGE: 1.000
GAIN: 46	THRESH1: 4
GATE1: 0.040	WIDTH1: OFF
HOLD2: OFF	LOG: B002

- 1) Press the **MEAS** key once to activate measure menu items. Press the **MEAS** key multiple times to move right and the **ESC** key multiple times to move left until the **LOG** cell is highlighted.

NAME: GRID LOG			
	A	B	C
1	0.273	0.300	
2	0.523		
3			
4			

- 2) Press the **ENTER** key to display the **Grid Log Box**.
- 3) Press the **UP**, **DOWN**, **LEFT**, and **RIGHT** arrow keys to scroll the stored readings and corresponding display view.

Note: As the cursor is moved to a different cell the display will be updated with the display view saved with the reading. Readings stored in memory are indicated by displaying a **MEM** in the top left corner of the measurement screen.

- 4) The user may opt to clear a specific reading and save a new one at any time. Press the **CLR** key in the appropriate cell location to clear the reading, take a new measurement, and press the **ENTER** key to save the new reading.
- 5) Abort displaying the **Grid** at any time by pressing the **MEAS** key.

10.5 Deleting Grids (Files)

Deleting Files

One File

- 1) Press the **MENU** key once to activate the menu items tab. Press the **MENU** key multiple times to tab right and the **ESC** key multiple times to tab left until the **DATA** menu is highlighted and displaying the submenu items.

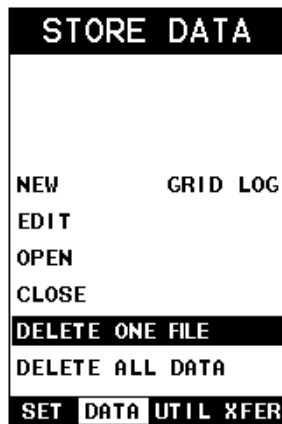

- 2) Use the **UP** and **DOWN** arrow keys to scroll through the sub menu items until **DELETE ONE FILE** is highlighted.

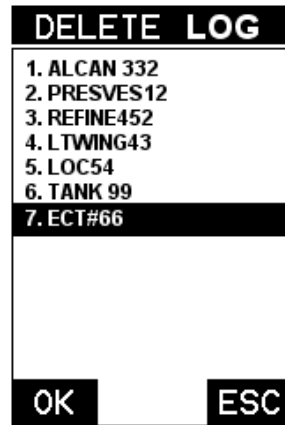

- 3) Press the **ENTER** key to display the **File List Box**.
- 4) Use the **UP** and **DOWN** arrow keys to scroll through the stored **Files** until the target **File** to delete is highlighted.
- 5) Press the **OK** key to delete the **File**.
- 6) Press the **MEAS** key to return to the measurement screen.

All Data

- 1) Press the **MENU** key once to activate the menu items tab. Press the **MENU** key multiple times to tab right and the **ESC** key multiple times to tab left until the **DATA** menu is highlighted and displaying the submenu items.

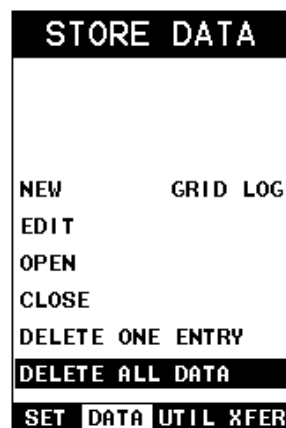

- 2) Use the **UP** and **DOWN** arrow keys to scroll through the sub menu items until **DELETE ALL DATA** is highlighted.

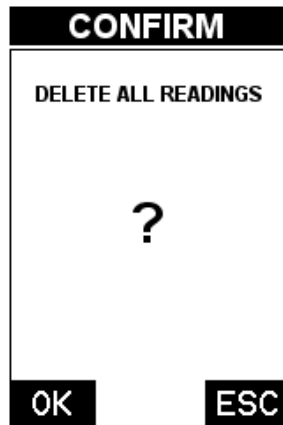

- 3) Press the **ENTER** key to activate the confirmation screen.
- 4) Press the **OK** key to delete **All Files** from memory, or the **ESC** key to abort.
- 5) Press the **MEAS** key to return to the measurement screen.

10.6 Editing a Grid (File)

Once a grid has been created and saved to memory, the user can edit the **Comments** or **Increment Direction** at a later time. The following procedures outline this process:

Editing a Grid

EDIT GRID LOG

NAME: BOILER 34

NOTE:

TOP LEFT: A001

LOWER RIGHT: C050

INCR. DIR EAST

SAVE GRAPHICS: OFF

SAVE CHANGES?

LOG SIZE 150

OK **ESC**

EDIT GRID LOG

NAME: BOILER 34

NOTE:

TOP LEFT: A001

LOWER RIGHT: C050

INCR. DIR EAST

SAVE GRAPHICS: OFF

SAVE CHANGES?

LOG SIZE 150

OK **ESC**

- 1) Press the **MENU** key once to activate the menu items tab. Press the **MENU** key multiple times to tab right and the **ESC** key multiple times to tab left until the **DATA** menu is highlighted and displaying the submenu items.
- 2) Use the **UP** and **DOWN** arrow keys to scroll through the sub menu items until **EDIT** is highlighted.
- 3) Press the **ENTER** key to display the **Edit List Box**.
- 4) Use the **UP** and **DOWN** arrow keys to scroll through the **Edit** options until **NOTE** or **INCR. DIR** is highlighted.

Note: If editing the **INCR. DIR**, simply use the **LEFT** or **RIGHT** arrow keys to scroll **NONE**, **NORTH**, **EAST**, **SOUTH**, **WEST** for a Grid, or **INC**, **DEC** for a Seq Log. **Proceed to step 10.**

LOG NOTE	
Ø	123456789
!	' _ # █ / . - ()
A	B C D E F G H I J
K	L M N O P Q R S T
U	V W X Y Z
INSP#99 █	

OK	ESC
----	-----

- 5) Press the **ENTER** key to activate the **Alpha Edit box – Only used when editing the NOTE.**
- 6) Use the **UP, DOWN, LEFT, & RIGHT** arrow keys to highlight the appropriate alpha characters.
- 7) Press the **ENTER** key to select a character and advance to the next field of the **Comments.**
- 8) Use the **CLR** key to backspace if necessary.
- 9) Repeat steps **6 - 8** until the **Comments** are completed.

EDIT GRID LOG	
NAME: BOILER 34	
NOTE:	
TOP LEFT:	A001
LOWER RIGHT:	C050
INCR. DIR	EAST
SAVE GRAPHICS:	OFF
SAVE CHANGES?	
LOG SIZE	150
OK	ESC

10) Press the **UP** or **DOWN** arrow key to highlight **SAVE CHANGES**, and the **OK** key to activate the confirmation screen.

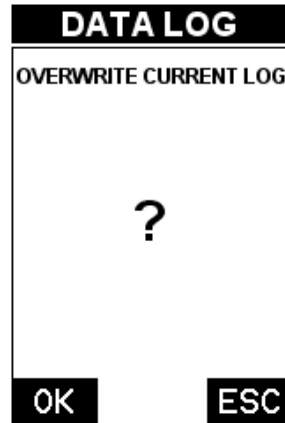

11) Press the **OK** key to save the changes or the **ESC** key to cancel editing the file parameters.

12) Press the **MEAS** key to return to the measurement screen.

10.7 Changing the active File - Open

The user may have transferred grid templates from a PC to the **MVX**, or setup grids using the **MVX** at an earlier time. The name of the currently active file is always displayed at the top of the **Grid Box** in measurement mode (refer to photo below). It's not only important to recognize what file is currently active, but also be able to change the active file at any time. The following procedures outline this process:

Active File

MEM	U: 0.2330		IN
COAT			MED
0.300			
COAT: 0.035			
NAME: BOILER 34			
	A	B	C
1	0.250	0.500	0.750
2	0.200	0.300	
3			
4			

- 1) Press the **MENU** key once to activate the menu items tab. Press the **MENU** key multiple times to tab right and the **ESC** key multiple times to tab left until the **DATA** menu is highlighted and displaying the submenu items.

STORE DATA	
NEW	SEQ LOG
EDIT	
OPEN	
CLOSE	
DELETE ONE ENTRY	
DELETE ALL DATA	
SET	DATA UTIL XFER

- 2) Use the **UP** and **DOWN** arrow keys to scroll through the sub menu items until **OPEN** is highlighted.

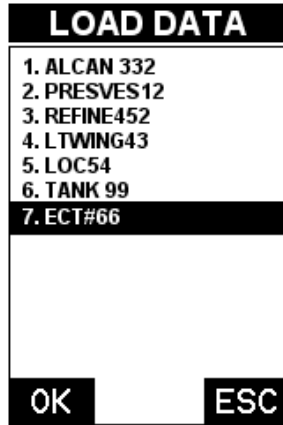

- 3) Press the **ENTER** key to display the **Grid/Seq List Box**.
- 4) Use the **UP** and **DOWN** arrow keys to scroll through the grids until the target grid is highlighted.

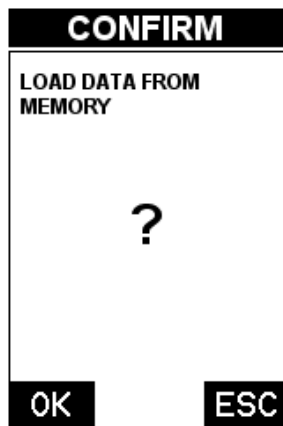

- 5) Press the **ENTER** key to activate the confirmation screen.
- 6) Press the **OK** key to load the file from memory.
- 7) Press the **MEAS** key to return to the measure screen.

10.8 Closing an active File - Close

A user might not have a current requirement to store measurements, but a file is currently open or active and needs to be closed. The following procedures outline how to close an open or active file:

Close an Active File

- 1) Press the **MENU** key once to activate the menu items tab. Press the **MENU** key multiple times to tab right and the **ESC** key multiple times to tab left until the **DATA** menu is highlighted and displaying the submenu items.

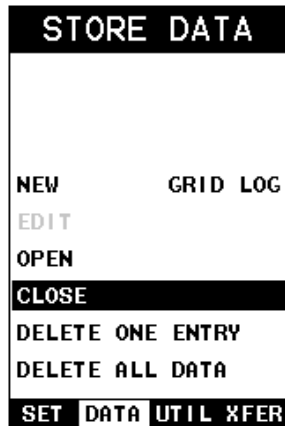

- 2) Use the **UP** and **DOWN** arrow keys to scroll through the sub menu items until **CLOSE** is highlighted.

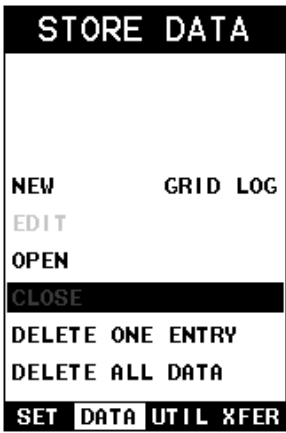

The screenshot shows a menu titled "STORE DATA" with the following options: "NEW", "GRID LOG", "EDIT", "OPEN", "CLOSE", "DELETE ONE ENTRY", "DELETE ALL DATA", and "SET DATA UTIL XFER". The "CLOSE" option is highlighted with a black background, indicating it is the active selection.

3) Press the **ENTER** key to close the active file. **Note:** Following the key press, the **CLOSE** text will be grayed out indicating the file has been close and is no longer active.

CHAPTER ELEVEN SETUPS – CREATE, STORE, EDIT, & RECALL

11.1 Introduction to Setups

Often times, users are faced with a variety of tasks and applications that are sometimes similar, but often times very different. With a standard thickness gauge, the user would have to recalibrate and setup for each individual application respectively. The increased number of features and parameters also adds to the overall setup time, or amount of time to set up marginal applications with perfection and understanding. Because of the additional time involved, the **MVX** has been equipped with the ability to save these setups to memory and loaded at any time. The **MVX** can store up to **64 custom setups**. These setups can be bi-directionally transferred to and from a PC. Therefore, the user can save as many setups as necessary for all their individual applications requirements. This saves a great deal of time and knowledge for future inspections of the same job or project, eliminates error between two or more users during the setup and calibration process.

11.2 Opening a Setup

The following procedures outline how to open factory and custom setups:

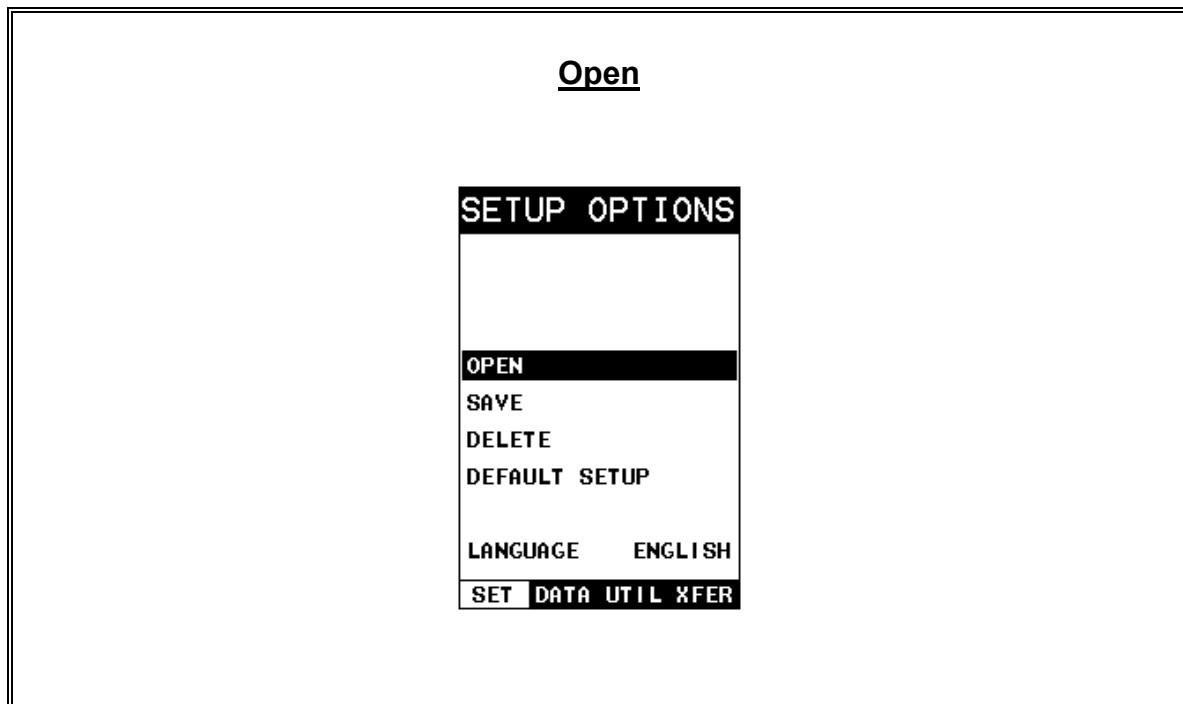

- 1) Press the **MENU** key once to activate the menu items tab. Press the **MENU** key multiple times to tab right and the **ESC** key multiple times to tab left until the **SETUP** menu is highlighted and displaying the submenu items.
- 2) Use the **UP** and **DOWN** arrow keys to scroll through the sub menu items until **OPEN** is highlighted.

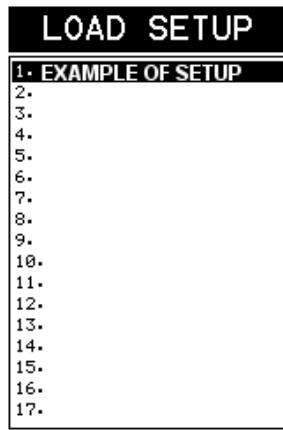

- 3) Press the **ENTER** key to display the **Setup List Box**.
- 4) Use the **UP** and **DOWN** arrow keys to scroll through the setups until the target setup is highlighted.

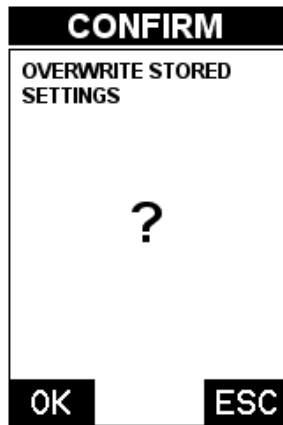

- 5) Press the **ENTER** key to activate the confirmation screen.
- 6) Press the **OK** key to load the setup from memory.
- 7) Press the **MEAS** key to return to the measure screen.

11.3 Saving a Setup

Once the *MVX* parameters and features have been adjusted for an application, the user may elect to save these settings to a specific setup location for future use. This can potentially save time and reduce error between users.

It is sometimes necessary to rename a previously saved setup, or add additional comments about a particular setup. The setup name may have been entered incorrectly, or the user needs to use the setup for a completely different project. An inspector's name or other comments about the project may also be required for additional documentation purposes. The following procedures outline the necessary steps for saving and editing a setup:

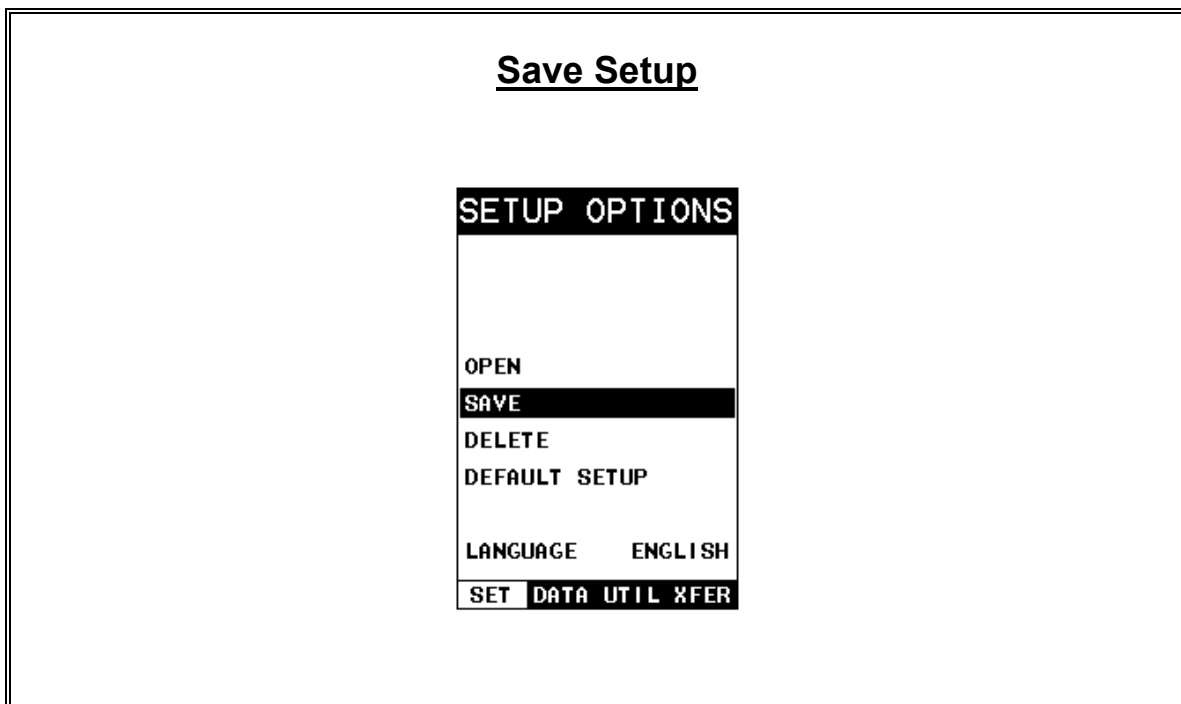

- 1) Press the **MENU** key once to activate the menu items tab. Press the **MENU** key multiple times to tab right and the **ESC** key multiple times to tab left until the **SETUP** menu is highlighted and displaying the submenu items.
- 2) Use the **UP** and **DOWN** arrow keys to scroll through the sub menu items until **SAVE** is highlighted.

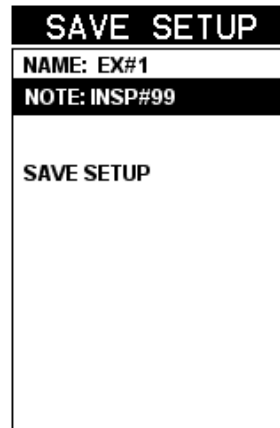
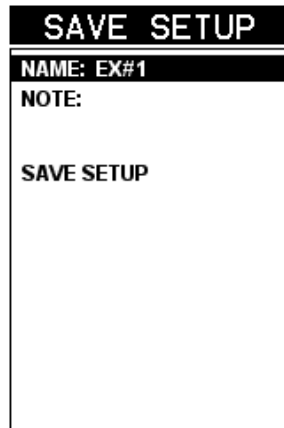

- 3) Press the **ENTER** key to display the **Save Setup Parameters List Box**.
- 4) Press the **UP** and **DOWN** arrow keys to scroll the **Name** and **Note** parameters.

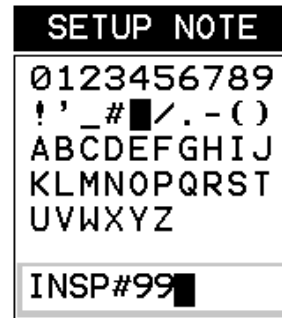

OK

ESC

OK

ESC

- 5) When the parameter to edit is highlighted, press the **ENTER** key to activate the **Alpha Edit Box**.
- 6) Use the **UP**, **DOWN**, **LEFT**, and **RIGHT** arrow keys to scroll through the characters, the **ENTER** key to select characters, and the **CLR** key to backspace through the characters, until the **Name** or **Note** fields have been edited.
- 7) Press the **OK** key to return to the **Save Setup Parameters List Box**.
- 8) If both parameters will be edited, **repeat steps 4 – 7**.

SAVE SETUP
NAME: EX#1 NOTE: INSP#99
SAVE SETUP

- 9) Use the **UP** and **DOWN** arrow keys to scroll to and highlight **SAVE SETUP**.
- 10) Press the **ENTER** key to activate the **Setup List Box**.

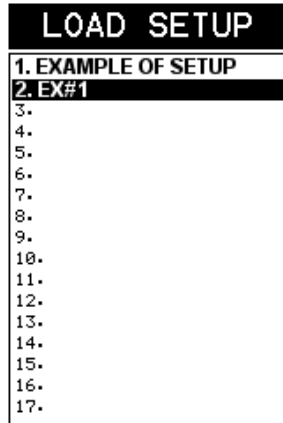

11) Use the **UP** and **DOWN** arrow keys to scroll through the setups until the target location to save the **Setup** is highlighted.

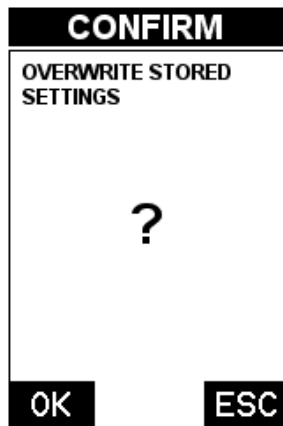

12) Press the **OK** key to activate the confirmation screen.

13) Press the **OK** key to save the **Setup**, or **ESC** to cancel saving the **Setup**.

14) Finally, press the **MEAS** key to return to the measurement screen.

Note: *The **Name** and **Comments** of the **Setup** can be edited at any time by simply repeating the **Save Setup** routine described above. Therefore, **the Save Setup** function can also be considered an **Edit Function**.*

11.4 Deleting a Saved Setup

This option allows a user to delete setup files that were previously saved and no longer needed. It's a simple feature to allow the user to do a bit of "house cleaning".

Delete Setup

SETUP OPTIONS

OPEN

SAVE

DELETE

DEFAULT SETUP

LANGUAGE ENGLISH

SET DATA UTIL XFER

- 1) Press the **MENU** key once to activate the menu items tab. Press the **MENU** key multiple times to tab right and the **ESC** key multiple times to tab left until the **SETUP** menu is highlighted and displaying the submenu items.
- 2) Use the **UP** and **DOWN** arrow keys to scroll through the sub menu items until **DELETE** is highlighted.

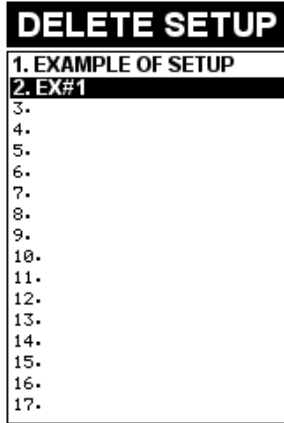

- 3) Press the **ENTER** key to display the **Setups List**.
- 4) Press the **UP** and **DOWN** arrow keys to scroll to the **Setup Name**.
- 5) When the **Setup Name** is highlighted, press the **ENTER** key to display the confirmation screen.

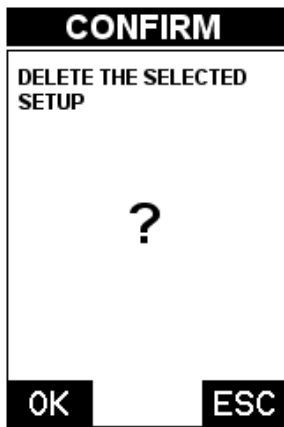

- 6) Press the **OK** key to delete the **Setup File**.
- 7) Finally, press the **MEAS** key to return to the measurement screen.

11.5 Using the Default Setup

The default setup feature was added to the **MVX** to use, as a last resort, if there are no setups stored in the gauge –factory or otherwise. The only time this might possibly occur is if the setup file in the **MVX** was somehow corrupted, and the user does not have access to a computer to re-load the factory setups back into the **MVX**. This gives the user the ability to load and modify a basic setup as follows:

Note: *The default file contains no probe zero data. Therefore, a zero must be performed after loading. Also, the default setup can be loaded when using the flaw mode feature, to eliminate the probe zero delay value, and start at the initial pulse or zero.*

Default Setup

SETUP OPTIONS	
OPEN	
SAVE	
DELETE	
DEFAULT SETUP	
LANGUAGE	ENGLISH
SET DATA UTIL XFER	

- 1) Press the **MENU** key once to activate the menu items tab. Press the **MENU** key multiple times to tab right and the **ESC** key multiple times to tab left until the **SETUP** menu is highlighted and displaying the submenu items.
- 2) Use the **UP** and **DOWN** arrow keys to scroll through the sub menu items until **DEFAULT SETUP** is highlighted.
- 3) Finally, press the **MEAS** key to return to the measurement screen.

11.6 Selecting a Language

The *MVX* is equipped with a language option. Currently, the only languages supported are English, Spanish, German, French, Hungarian, Czech, however the list continues to grow. Check with Dakota for an updated list. The steps to select one of these languages are outlined as follows:

Language



```
SETUP OPTIONS
OPEN
SAVE
DELETE
DEFAULT SETUP
LANGUAGE ENGLISH
SET DATA UTIL XFER
```

- 1) Press the **MENU** key once to activate the menu items tab. Press the **MENU** key multiple times to tab right and the **ESC** key multiple times to tab left until the **SETUP** menu is highlighted and displaying the submenu items.
- 2) Use the **UP** and **DOWN** arrow keys to scroll through the sub menu items until **LANGUAGE** is highlighted.
- 3) Press the **LEFT** and **RIGHT** arrow keys to toggle the language options.
- 4) Once the desired language is displayed, press the **MEAS** key to return to the measurement screen.

CHAPTER TWELVE USING THE UTILITY SOFTWARE

12.1 Computer System Requirements

DakView will run on many different operating systems: Windows XP, Windows 2000 Professional, Windows 2000 Server, Windows 2000, Vista, Windows 7, 8, 10, or advanced Server operating systems running on Intel or AMD hardware. Additionally there is a version for the Mac OSX platform.

A Pentium 166MHz or faster processor with at least 32 megabytes of physical RAM is required. You should have 40 megabytes of free disk space before attempting to install **DakView**.

File transfer is standard USB connectivity, using a USB-C to USB transfer cable (pt# N-003-0330).

12.2 Installing DakView

DakView is available directly from our website for download free of charge. Stay current by periodically checking the website for the latest version. Simply download the .exe file from our website to your computer, and double click the icon to begin installation. Refer to the online help section in **DakView** for operating instructions.

12.3 Communicating with the *MVX*

DakView will not directly communicate with the *MVX* series gauges. The *MVX* is equipped with USB, acting as a Thumb Drive (external storage device) when connected to a computer and powered on. Therefore, the SD memory card can be opened as a drive with *directory structure, similar to the C: on your computer. The files stored on the internal SD can be simply copied (dragged) into any folder on your PC and opened using DakView.* The PC software will function as a file viewer for the *MVX* series gauges.

12.4 Line Power

The *MVX* can be powered using the standard USB-C to USB-A data cable (N-003-0330), by connecting directly to a USB port on your computer, or using a standard cell phone power adapter directly to an outlet. This is a convenient way to power the gauge for specific bench top applications in a factory line environment.

12.5 Upgrading the *MVX*

The *MVX* can be upgraded to the latest revision of firmware at any time. Simply download the latest version posted on the Dakota Ultrasonics website, copy the upgrade file to the main drive directory *MVX*, and use the upgrade utility located in the **XFER** menu. The process is very easy and convenient, allowing our users to stay current with updated feature additions and bug fixes. The procedure to upgrade your *MVX* is outlined below:

Upgrading the Firmware

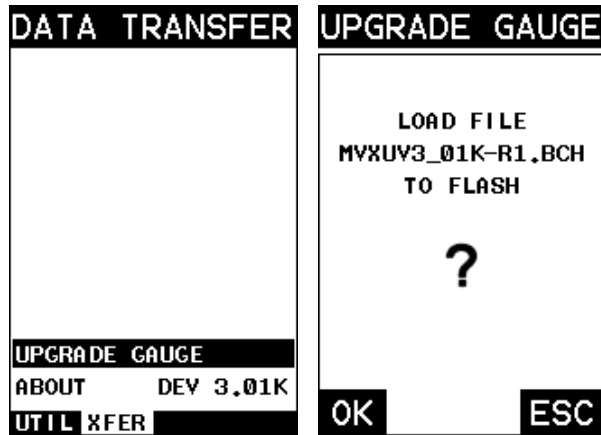

- 1) Press the **MENU** key once to activate the menu items tab. Press the **MENU** key multiple times to tab right and the **ESC** key multiple times to tab left until the **XFER** menu is highlighted and displaying the submenu items. Alternatively, press the **LEFT** and **RIGHT** arrow keys multiple times using the left button wheel.
- 2) Press the **ENTER** key to display the upgrade confirmation screen, followed by pressing **OK** key to start the upgrade process.

Note: *The **MVX** will power down and the alarm lights will flash during the upgrade process.*

APPENDIX A - VELOCITY TABLE

Material	sound velocity in/us		sound velocity m/s
Aluminum	0.2510		6375
Beryllium	0.5080		12903
Brass	0.1730		4394
Bronze	0.1390		3531
Cadmium	0.1090		2769
Columbium	0.1940		4928
Copper	0.1830		4648
Glass (plate)	0.2270		5766
Glycerine	0.0760		1930
Gold	0.1280		3251
Inconel	0.2290		5817
Iron	0.2320		5893
Cast Iron	0.1800	(approx)	4572
Lead	0.0850		2159
Magnesium	0.2300		5842
Mercury	0.0570		1448
Molybdenum	0.2460		6248
Monel	0.2110		5359
Nickel	0.2220		5639
Nylon	0.1060	(approx)	2692
Platinum	0.1560		3962
Plexiglas	0.1060		2692
Polystyrene	0.0920		2337
PVC	0.0940		2388
Quartz glass	0.2260		5740
Rubber vulcanized	0.0910		2311
Silver	0.1420		3607
Steel (1020)	0.2320		5893
Steel (4340)	0.2330		5918
Steel Stainless"	0.2230		5664
Teflon	0.0540		1372

Tin	0.1310		3327
Titanium	0.2400		6096
Tungsten	0.2040		5182
Uranium	0.1330		3378
Water	0.0580		1473
Zinc	0.1660		4216
Zirconium	0.1830		4648

**APPENDIX B -
SETUP LIBRARY**

Num	Name	Comment 1	Gn/AGC	Velocity
1	Enter Custom Name			
2	...			
3	...			
4	...			
5	...			
6	...			
...	...			

WARRANTY INFORMATION

• Warranty Statement •

Dakota Ultrasonics warrants the *MVX* against defects in materials and workmanship for a period of two years from receipt by the end user. Additionally, Dakota Ultrasonics warrants transducers and accessories against such defects for a period of 90 days from receipt by the end user. If Dakota Ultrasonics receives notice of such defects during the warranty period, Dakota Ultrasonics will either, at its option, repair or replace products that prove to be defective.

Should Dakota Ultrasonics be unable to repair or replace the product within a reasonable amount of time, the customer's alternative exclusive remedy shall be refund of the purchase price upon return of the product.

• Exclusions •

The above warranty shall not apply to defects resulting from: improper or inadequate maintenance by the customer; unauthorized modification or misuse; or operation outside the environmental specifications for the product.

Dakota Ultrasonics makes no other warranty, either express or implied, with respect to this product. Dakota Ultrasonics specifically disclaims any implied warranties of merchantability or fitness for a particular purpose. Some states or provinces do not allow limitations on the duration of an implied warranty, so the above limitation or exclusion may not apply to you. However, any implied warranty of merchantability or fitness is limited to the five-year duration of this written warranty.

This warranty gives you specific legal rights, and you may also have other rights which may vary from state to state or province to province.

• Obtaining Service During Warranty Period •

If your hardware should fail during the warranty period, contact Dakota Ultrasonics and arrange for servicing of the product. Retain proof of purchase in order to obtain warranty service.

For products that require servicing, Dakota Ultrasonics may use one of the following methods:

- Repair the product
- Replace the product with a re-manufactured unit
- Replace the product with a product of equal or greater performance
- Refund the purchase price.

• After the Warranty Period •

If your hardware should fail after the warranty period, contact Dakota Ultrasonics for details of the services available, and to arrange for non-warranty service.



PC Software & Firmware

Note: All software downloads and upgrades are available on our website at no additional charge. Take advantage and stay current.

www.dakotaultrasonics.com